



# TROUBLE IN TOYLAND

The 32<sup>nd</sup> Annual Survey of Toy Safety

November 2017

**CALPIRG**  
Education Fund

# Trouble in Toyland

The 32<sup>nd</sup> Annual Survey of Toy Safety



Written by:

Dev Gowda, Kara Cook-Schultz, and Ed Mierzwinski

U.S. PIRG Education Fund

November 2017

# Acknowledgments

CALPIRG Education Fund thanks the Colston Warne program of Consumer Reports for supporting our work on consumer protection issues. Additional thanks to individual contributors for their generous support of our work on toxics, public health, and consumer issues.

The authors bear responsibility for any factual errors. Policy recommendations are those of CALPIRG Education Fund. The views expressed in this report are those of the authors and do not necessarily reflect the views of our funders or those who provided review.

© 2017 CALPIRG Education Fund. Some Rights Reserved. This work is licensed under the Creative Commons Attribution-NonCommercial-NoDerivatives 4.0 International License. To view a copy of this license, visit <http://creativecommons.org/licenses/by-nc-nd/4.0/> or send a letter to Creative Commons, PO Box 1866, Mountain View, CA 94042, USA. All images of recalled toys were taken from the CPSC website. All other pictures of toys were taken by CALPIRG Education Fund staff. The CPSC did not contribute to this report nor does it endorse this report, CALPIRG Education Fund, or its affiliates.

With public debate around important issues often dominated by special interests pursuing their own narrow agendas, CALPIRG Education Fund offers an independent voice that works on behalf of the public interest. CALPIRG Education Fund, a 501(c)(3) organization, works to protect consumers and promote good government. We investigate problems, craft solutions, educate the public, and offer meaningful opportunities for civic participation. For more information about CALPIRG Education Fund or for additional copies of this report, please visit [www.calpirgedfund.org](http://www.calpirgedfund.org).

*Report layout and cover design: Alec Meltzer, [meltzerdesign.net](http://meltzerdesign.net)*

*Cover photo: Jack.Q/Bigstock*

# Table of Contents

<b>Executive Summary</b> . . . . .	<b>1</b>
<b>Introduction</b> . . . . .	<b>4</b>
<b>Toy Safety Milestones</b> . . . . .	<b>4</b>
<b>Hazards in Toys</b> . . . . .	<b>7</b>
<b>Toxic Hazards</b> . . . . .	<b>7</b>
Lead. . . . .	7
Phthalates . . . . .	9
<b>Choking Hazards</b> . . . . .	<b>9</b>
Small Parts . . . . .	9
Small Balls. . . . .	10
Balloons . . . . .	11
Magnets . . . . .	11
<b>Data-Collecting Toys &amp; FBI Alert</b> . . . . .	<b>13</b>
<b>Excessive Noise</b> . . . . .	<b>14</b>
<b>Overheating of Batteries and Chargers</b> . . . . .	<b>15</b>
<b>Recommendations</b> . . . . .	<b>16</b>
<b>CPSC-Recalled Toys from October 20, 2016 to October 5, 2017</b> . . . . .	<b>18</b>
<b>Methodology</b> . . . . .	<b>50</b>
<b>Appendix 1. Potentially Hazardous Toys</b> . . . . .	<b>51</b>
<b>Appendix 2. Reported Toy-Related Deaths, 2001-2015</b> . . . . .	<b>61</b>
<b>Appendix 3. CPSC Characteristics of Toys for Children Under Three</b> . . . . .	<b>62</b>
<b>Endnotes</b> . . . . .	<b>63</b>

# Executive Summary

For over 30 years, U.S. PIRG Education Fund has conducted an annual survey of toy safety, which has led to over 150 recalls and other regulatory actions over the years, and has helped educate the public and policymakers on the need for continued action to protect the health and wellbeing of children.

Toys are safer than ever before, thanks to decades of work by product safety advocates, parents, the leadership of Congress, state legislatures, and the Consumer Product Safety Commission (CPSC).

Among the toys surveyed this year, we found potential choking hazards, and two products with concentrations of lead exceeding federal standards for children's products. We also found data-collecting toys that may violate children's privacy laws. This report not only lists the potentially dangerous toys that we found this year, but also describes why and how the toys could harm children.

The continued presence of hazards in toys highlights the need for constant vigilance on the part of government agencies and the public to ensure that unsafe toys do not harm children.

Researchers also examined toys recalled by the CPSC between October 2016 and October 2017 and looked at whether they appeared to still be available for sale online. Researchers did not find any recalled toys for sale online. However, parents

should watch out for recalled toys that could still be in their homes. Over the past 12 months, the CPSC, in cooperation with manufacturers and distributors, has announced over 30 recalls of toys and children's products totaling over 6.5 million units.

Standards for toy safety are enforced by the CPSC. Safety standards include limits on toxic substances in children's products, size requirements for toys for small children, warning labels about choking hazards, measures to keep magnets and batteries inaccessible, and noise limits.

**U.S. PIRG Education Fund staff examined toys to confirm that they are safe. We discovered that unsafe toys remain widely available. The problems we found include:**

- **Lead:** Even low levels of lead in blood have been shown to undermine IQ, attentiveness, and academic achievement. Our shoppers identified two fidget spinners that contained excessive levels of lead. Unfortunately, the CPSC chose not to classify these fidget spinners as toys so they will not be regulated under federal standards for lead in children's products. We believe that these fidget spinners are marketed for children under 12 years and should therefore be classified as toys.

- **Small parts** are pieces that might block a child’s airway. Children, especially those under age three, can choke on small parts. Our shoppers identified several toys that contain small parts, but do not have any warning label at all. These included a peg game as well as golf and football travel games.
- **Balloons** are easily inhaled in attempts to inflate them and can become stuck in children’s throats. Balloons are responsible for more choking deaths among children than any other toy or children’s product. We found five balloon sets on store shelves that are either marketed to children under eight or have misleading warning labels that make it appear that they are safe for children between ages three and eight.
- **Privacy-Invasive Toys:** We alert parents and toy givers, for the first time, to so-called “connected toys” that may violate children’s privacy and other consumer protection laws. As more and more products are part of the “Internet of Things,” data collection and the sharing of consumer information become greater concerns. As an example, we list a doll, “My Friend Cayla,” which has been banned in Germany for privacy violations and is the subject of a complaint by several consumer groups to the U.S. Federal Trade Commission because it may violate the Children’s Online Privacy Protection Act. In July, the Federal Bureau of Investigation (FBI) issued a warning to consumers to “consider cyber security prior to introducing smart, interactive, internet-connected toys into their homes.”

Despite recent progress in making toys safer, toys are still being recalled for hazards such as overheating and choking hazards. To keep children safe from potentially hazardous toys, there is still more to do.

**Policymakers should continue building upon recent progress in the strengthening of toy safety standards.**

- Maintain the CPSC’s funding and authorities to protect the public; and,
- Understand that regulations protect health and safety.

**The CPSC should improve recall effectiveness:**

- Engage in efforts to increase consumer and researcher awareness of the public hazard database SaferProducts.gov;
- Aggressively seek to increase recall effectiveness by making sellers agree to conduct more effective outreach campaigns that stress the real hazard posed, rather than simply promote the purported good will of the firm;
- Perform regular online sweeps checking for the availability of previously-recalled toys; and,
- Hold companies reselling recalled products accountable, which also sends a message to others.
- The CPSC should continue to enforce and improve strong safety standards:
- Continue to enforce vigorously the Consumer Product Safety Improvement Act’s mandatory standards for toys, including strict limits on lead and lead paint in any toys, jewelry or other articles for children under 12 years;
- Vigorously enforce the Consumer Product Safety Improvement Act’s permanent ban on the use of three specific phthalates in all toys and children’s products;

- Enlarge the small parts test tube to be more protective of children under three;
- Change the small-ball rule to include small round or semi-round objects, and not just “balls” in the strictest definition, since these toys pose the same hazards as small balls (this is especially true of rounded toy food, since it is “intended” to be eaten);
- Enforce the use of the United States’ statutory choke hazard warning label, as many toys now are wrongly labeled with less explicit foreign warnings; and
- Continue to enforce CPSC rules requiring online warning labels.
- Classify all fidget spinners as toys and hold them to federal standards for children’s products.
- Examine toys carefully for hazards before purchase – and don’t trust that they are safe just because they are on a store shelf. Check the CPSC recall database at CPSC.gov before buying toys online;
- Report unsafe toys or toy-related injuries to the CPSC at Saferproducts.gov;
- Remember, toys on our list are presented as examples of previously recalled toys only. Other hazards may exist;
- Review the recalled toys list in this report and compare it to toys in your children’s toy boxes; and
- Put small parts, or toys broken into small parts, out of reach. Regularly check that toys appropriate for your older children are not left within reach of children who still put things in their mouths.

**Parents and caregivers can also take steps to protect children from potential hazards. We recommend that parents:**

- Subscribe to email recall updates from the CPSC and other U.S. government safety agencies available at [www.recalls.gov](http://www.recalls.gov);
- Shop with U.S. PIRG Education Fund’s Toy Safety Tips, available at [toysafetytips.org](http://toysafetytips.org);
- Eliminate small magnet hazards from your home.
- Be aware that toys connected to the Internet, as well as apps and websites, may be collecting information about children inappropriately. Learn more about the Children’s Online Privacy Protection Act (COPPA).

# Introduction

Toys are safer than ever before, thanks to decades of work by product safety advocates, parents, the leadership of Congress, state legislatures and the Consumer Product Safety Commission (CPSC). Nonetheless, from October 2016 to October 2017 the CPSC, in cooperation with manufacturers and distributors, has announced over 30 recalls of toys and children's products totaling over 6.5 million units.

**This year is the 32nd annual release of our Trouble in Toyland report. This year, we emphasize three warnings to parents and toy givers:**

- Look out for the two fidget spinner models we found to contain excessive levels of lead; if you have already purchased these fidget spinners, place them in a plastic bag and remove them from your homes.
- Recalls are often not effective in reaching consumers. You may have previously recalled toys at home. We urge you to check our list.
- Data-collecting toys like the dolls we highlight in our report may violate children's privacy and other consumer protection laws.

Choking on small parts, small balls and balloons remains a leading cause of toy-related deaths and injuries. Some toys can pose hidden hazards, exposing children to dangerous chemicals that are linked to serious health problems. Other emergent hazards the CPSC has addressed in recent years are posed by small powerful rare earth magnets.

Key parts of the Consumer Product Safety Improvement Act (CPSIA) of 2008 recognized the growing threat of toxic chemicals. It gave CPSC authority to enforce strict limits on lead, other heavy metals, and phthalates in toys and children's products.

In 2015 (the last year for which data are available), there were 254,200 toy-related injuries treated in U.S. hospital emergency departments, and 11 toy-related deaths.<sup>1</sup> But despite lingering dangers, in the last 30 years we've come a long way in terms of both policy and compliance with standards.

## Toy Safety Milestones

### **Small Parts Ban (1979):**

The CPSC small parts ban prohibited sale of toys or balls intended for children under 3 containing parts, or that could easily break into parts, smaller than a small parts test cylinder.



## **The Child Safety Protection Act of 1994**

From 1980-1992, the Consumer Product Safety Commission (CPSC) and Congress did little to protect children from dangerous products. Throughout that period, PIRG and other consumer groups lobbied Congress and the CPSC to increase the size of the small parts choking hazard test and to require appropriate choke hazard warning labels on toys for older children. A 1992 campaign led by ConnPIRG and a number of child safety advocates resulted in a choke hazard warning label law that took effect in Connecticut in 1993. The Connecticut law, upheld in the courts by the state Attorney General, laid the groundwork for a federal standard.

In 1994, after years of battling the influential and powerful toy lobby, Congress finally passed a child safety proposal championed by PIRG and other safety organizations including the Consumer Federation of America and Consumers Union. The Child Safety Protection Act (CSPA), which took effect in January 1995, required explicit choke hazard warning labels on all toys containing small parts intended for children ages three to six, and the same warnings were required on balloons, small balls, and marbles. It also increased the size of banned small balls, as round objects are especially dangerous choking hazards. This legislation was a powerful first step towards safer toys.

## **The Consumer Product Safety Improvement Act of 2008**

In 2008, after a series of record-breaking toy recalls—including millions of units of lead-laden brand name, iconic toys, Congress passed the Consumer Product Safety Improvement Act (CPSIA), which gave the CPSC broad new powers to speed up recalls and hold toy manufacturers more accountable; the act also set stricter bans on lead, phthalates and

other toxic chemicals in children's products. Positively, the CPSC recently took action to expand certain phthalate bans under the 2008 act.<sup>2</sup> Importantly, the act also required third-party testing of toys at CPSC-approved laboratories and also established a public database, safer-products.gov, where consumers can file complaints about hazards posed by any CPSC-regulated product, from toys to toasters and electric ranges.

Since 2008 and the passage of the CPSIA, the number of children's products recalled on a yearly basis has continued to decline -- whereas before the law, recalls were increasing. This data shows that the CPSIA has had a role in reversing a dangerous trend.

## **New Regulation Includes A Ban On Certain Small Powerful Magnets (2014)**

Rare earth magnets sold over the last 15 years are much more powerful than older magnets. Small powerful magnets are found in construction sets, puzzles, toy jewelry, action figures, board games, and train sets, and are also used in products geared towards adults like desk toys and stress relievers. Numerous incidents reported to the CPSC made it clear that children can swallow several magnets and suffer serious injuries requiring emergency surgery when they bind together across intestinal walls. Between 2009 and 2013, the CPSC estimates that high-powered magnets led to approximately 2,900 emergency room-treated injuries. Following regulatory activity, including recalls and lawsuits against several magnet sellers, the CPSC issued a stricter regulation in 2014 that bans the sale of certain small, powerful magnets, regardless of any age labeling asserting that they were "adult desk stress toys," not children's products. However, the regulation was challenged by Zen Magnets and vacated by a U.S. appellate

court in November 2016.<sup>3</sup> In October 2017, a CPSC administrative law judge reinstated a CPSC “Stop Sale” order against Zen Magnets.<sup>4</sup> Zen Magnets has initiated a legal challenge to the order in the U.S. courts; other manufacturers and distributors also seek entry into the marketplace.

### **The Road To Safer Toys**

In the past thirty years, the *Trouble in Toyland* report has led to over 150 recalls and other actions by manufacturers, retailers, and the CPSC.

Going forward, we are pleased with the progress we have made and will continue to advocate for improving choking hazard rules and banning more toxic chemicals. We will also fight against general attacks on consumer protection regulations that affect the CPSC and other agencies.

Dangers are still present, and parents and regulators must remain vigilant, but there are many signs of progress toward safer toys and children’s products. From legislation like the Consumer Product Safety Improvement Act to recent phthalate and magnet limits, 30+ years of *Trouble in Toyland* has made children safer.

### **The Need To Improve Recall Effectiveness**

Yet despite these improvements, making recalls faster and more effective remains a challenge. Not enough consumers hear about recalls and not enough of those who do may take action. This year’s report focuses on warning parents and caregivers of the threat posed by recently-recalled toys that you may have at home but haven’t heard about.

We also warn retailers and distributors, as well as resellers, particularly Internet sites, that it is illegal to sell previously-recalled products. Most brick and mortar stores have instituted inventory control “lock-outs” that prevent a recalled toy a consumer finds on the shelf from being purchased at the checkout. The CPSC has increased efforts to reach out to second-hand stores and monitor Internet sellers.

Yet despite these improvements, making recalls faster and more effective remains a challenge. Not enough consumers hear about recalls and not enough of those who do take action. While not a toy-related death, a toddler death occurred in May 2017, well after a IKEA furniture tipover recall instituted in June 2016. The tragedy has drawn new attention to the need for more action on recall effectiveness.<sup>5</sup>

# Hazards in Toys

**D**espite progress in recent years, some toys and children's products still have the potential to cause harm. Depending on the materials used and the quality and nature of the product itself, the risks for children posed by toys and other products range from choking on small parts to suffering from dangerous chemical reactions in the body. In extreme cases, the consequences can be fatal. This section describes the most common hazards for children, and the federal standards relevant to each hazard.

## Toxic Hazards

### Lead

Despite the CSPIA and stronger enforcement by the CPSC, toys containing metals that pose a health risk to children continue to make it onto American store shelves. While the CPSC did not recall a toy due to lead over the past year,<sup>6</sup> our tests this year identified two fidget spinners containing high levels of lead.

Elemental lead is a soft metal occurring naturally in soils and rocks. It has a variety of commercial uses including in batteries, plastics, and radiation shield-

ing. In the past, lead was also added to gasoline and paint.<sup>7</sup> Because of lead's toxicity, in 1978 it was banned in household paint, in products marketed to children, and in dishes and cookware in the United States.<sup>8</sup> Lead is not discernible by sight or smell. Lead exposure is particularly damaging for young children because of its impact on development. Even low levels of lead in blood have been shown to undermine IQ, attentiveness, and academic achievement. The Centers for Disease Control and Prevention (CDC) makes clear that any amount of lead in a child's blood is unsafe.<sup>9</sup> Moreover, since the effects of lead exposure cannot be reversed, it is especially important to prevent lead exposure to children in the first place. Unfortunately, toys can pose a risk in part because lead is used in other countries and can be found in imported products.<sup>10</sup> Additionally, lead may be incorporated into plastic.<sup>11</sup> Lead is used to soften plastic and make it more flexible, but when the plastic is exposed to sunlight, air, or detergents, the chemical bond between the lead and plastic breaks down, forming lead dust. Children can inhale or come in contact with this dust when they put toys in or near their mouths.<sup>12</sup> Lead in toys continues to be an issue.

### Federal Standards for Lead

With a few exceptions, federal law requires that all children's products manufactured after August 2011 contain no more than 100 parts per million (ppm) of total lead content in all accessible parts.<sup>13</sup> The CPSC defines accessible parts as parts that a child could reach through "normal and reasonably foreseeable use and abuse of the product."<sup>14</sup>

- Paint or similar surface coatings on all children's products are subject to a limit of 90 ppm of total lead. (Household paints are also subject to this rule.)
- Exceptions to these standards include metal components of bicycles, which cannot contain more than 300 ppm of lead. Components in electronic devices, some used children's products, inaccessible parts, and other items are exempt from the lead standard.<sup>15</sup>

Note that these limits do not meet the recommendations of the American Academy of Pediatrics (AAP), which recommends that all products intended for use by children contain no more than trace amounts of lead, defined as 40 ppm, the high end of typical lead concentrations in uncontaminated soil.<sup>16</sup>

### Toy Survey Findings: Lead

This year, our lab tests revealed excessive levels of lead in two fidget spinners. The Fidget Wild Premium Spinner Brass center circle tested for 33,000 ppm lead and its arm tested for 22,000 ppm of lead. Although the fidget spinner box includes a "Ages 14+" label, at the time of our laboratory testing, the website where it was available for sale included a statement that it is for children 6+ and specifically stated that it is "framed as a toy".<sup>17</sup> See screenshot from online store website in Appendix 1. The Fidget Wild Premium Spinner Metal's center circle tested for 1,300 ppm of lead and its arm tested for 520 ppm of lead. The item was found in the toy aisle of the store along with other fidget spinners that are labeled for children under 12 years.

Reinforcing an earlier statement by the CPSC's acting chairman that a fidget spinner has to be marketed to kids 12 and younger to be held to federal safety standards for children's products,<sup>18</sup> the CPSC sent our researchers an email (screenshot below) informing them that the CPSC has determined that the fidget spinners we identified, are not toys, but rather general use products, and are therefore not subject to federal lead standards for children's products. We disagree. U.S. PIRG Educa-

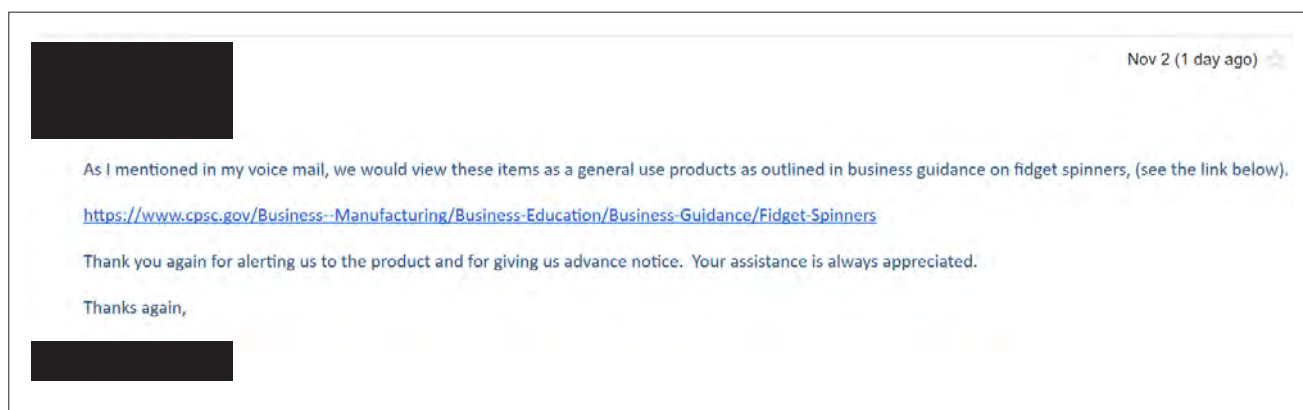

Screenshot of email from CPSC.

tion Fund staff found the fidget spinners that we identified in the toy aisle of Target, and one on the Target.com website, which, at the time of our testing, included statements that the product is “framed as a toy” and is suitable for children ages 6 and up.<sup>19</sup> Furthermore, common sense dictates that fidget spinners are meant for kids and should therefore be classified as children’s products. A simple online search for fidget spinners and children produces several images and videos of children playing with all types of fidget spinners. U.S. PIRG Education Fund calls on the CPSC to classify all fidget spinners as toys and hold them to the federal standard for lead in children’s products.

U.S. PIRG Education Fund staff reached out to Target, Corp. and Bulls i Toy, L.L.C, the distributor of the fidget spinners, with our test results. Both companies claimed that these fidget spinners are general use products, and not children’s products subject to legal limits for lead, because they contain a 14+ label. Therefore, neither company will issue a recall or remove them from store shelves.<sup>20</sup>

## Phthalates

Phthalates are a group of chemicals used to soften and increase the flexibility of plastics like polyvinyl chloride (PVC), which is brittle in its original formulation. The plastics industry uses large amounts of phthalates in products such as home siding, flooring, furniture, food packaging, clothing, and toys. Phthalates are also commonly used in industrial products like solvents, lubricants, glue, paint, sealants, insecticides, detergent, and ink.<sup>21</sup>

Research has documented the potential damage of exposure to phthalates at crucial stages of development, including altered development of the male reproductive system and early puberty.<sup>22</sup> At least one type of phthalate is suspected of causing cancer.<sup>23</sup> While the CPSC has not had a toy recall over the past year for

excessive levels of phthalates, in October 2017, the CPSC issued a final rule prohibiting children’s toys and child care articles containing more than 1,000 ppm of five additional phthalate chemicals.<sup>24</sup>

## Federal Standards for Phthalates

- The CPSIA banned three types of phthalates (DEHP, DBP and BBP) at levels greater than 1,000 ppm in the plasticized parts of child care articles and toys.
- The CPSC’s new regulation bans five additional phthalates (DINP, DPENP, DHEXP, DCHP, and DIBP) at levels greater than 1,000 ppm in the plasticized parts of child care articles and toys.<sup>25</sup>

## Choking Hazards

Small parts in toys, small balls, and balloons all present potential choking hazards. Choking is the leading form of toy-related death. From 2001 to 2015, 114 children died from choking on or asphyxiation by a play item.<sup>26</sup> See Appendix 2. Toys containing small parts – for example, a miniature comb for a doll’s hair, or small, interlocking construction blocks – may present a choking hazard for children, especially those under the age of three. Younger children are at a stage of childhood development in which mouthing or biting objects is common, increasing the risk that a small toy or component will get lodged in the windpipe.

## Small Parts

The CPSC defines a “small part” as anything that fits inside an official choke test cylinder, which has an interior diameter of 1.25 inches and a slanted bottom with a depth ranging from 1 to 2.25 inches (see Figure 1). This cylinder is the approximate

size of the fully expanded throat of a child under the age of three. If a toy or part of a toy – including any part that breaks off or separates during “use and abuse” testing – fits inside the test cylinder, the product constitutes a choking hazard.<sup>27</sup>

#### Federal Standards for Small Parts:

- Federal law bans the sale of toys containing small parts if the toy is intended for use by children under the age of three.
- Toys with small parts intended for children between the ages of three and six years old must include the following explicit choke hazard warning:<sup>28</sup>



Figure 1. Choke Test Cylinder

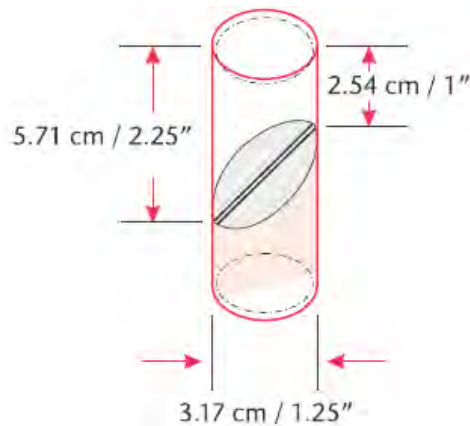

- Marbles, or toys containing marbles, as well as vending machines or toy bins selling products that may pose a choking hazard, are also required to post explicit warnings.<sup>29</sup> The CPSC uses several factors to determine whether a

toy is intended for children under three years old, including the manufacturer’s stated intent; age labeling on the product; the advertising and marketing of the product; and if the toy is “commonly recognized” as being intended for a child under three years.<sup>30</sup> A number of items, such as crayons, chalk, modeling clay, and finger paints are exempt from the small parts regulation because they cannot be manufactured in a way that would prevent them from breaking into small parts when subjected to “use and abuse” testing. Children’s clothing and accessories such as shoe lace holders, diaper pins, and barrettes are also exempt because they need to be small to perform their intended purpose.<sup>31</sup>

#### Toy Survey Findings: Small Parts

Our researchers identified three simple games for children between ages three and six years that contain small parts, yet lack a warning label or any age labeling. Small parts are acceptable in toys for children this age, provided the toy includes a choke hazard warning. We purchased a “Peg Game” as well as “Football” and “Golf” travel game sets that had very small parts that are a choke hazard. The packaging lacks the CPSC-required warning label for toys intended for children between three and six that contain small parts.

#### Small Balls

Since 1994, federal law has treated small balls in toys as a distinct choking hazard from small parts, one that is subject to more stringent standards. The law defines a ball as “any spherical, ovoid, or ellipsoidal object designed or intended to be thrown, hit, kicked, rolled, dropped, or bounced.” In addition, the term “ball” includes any multisided object formed by connecting planes into a generally spherical, ovoid, or ellipsoidal shape that is designated or intended to be used as a ball.<sup>32</sup>

As with small parts, the risk is particularly great for young children inclined to put objects in or near their mouths. Between 2001 and 2015, the most recent year for which data are available, small balls and marbles were responsible for 37 choking fatalities in children reported to the CPSC.<sup>33</sup> U.S. PIRG Education Fund believes that small balls are not the only round toys that are a choke hazard. We recommend that all round, ball-shaped toys pass not just the small parts test but the small ball test, too. Any small, rounded toy, such as items found in toy food sets, can choke a child.

### Federal Standards for Small Balls

- Balls with a diameter of less than 1.75 inches (as opposed to small parts which must fit into a cylinder 1.25 inches across) are banned for children younger than three years of age.<sup>34</sup> Toys that are spherical or have spherical parts, but are not intended for use as a ball, do not have to meet this standard.
- Any small ball intended for children over the age of three must include the following warning:<sup>35</sup>



**WARNING:**

CHOKING HAZARD--This toy is a small ball. Not for children under 3 yrs.

- A toy or game containing a small ball and intended for children between ages three and eight must include this warning:<sup>36</sup>



**WARNING:**

CHOKING HAZARD--Toy contains a small ball. Not for children under 3 yrs.

## Balloons

Balloons pose the most serious choking hazard to children in the United States. They are responsible for more childhood deaths by suffocation than any other product. Children can suffocate on balloons by accidentally inhaling while attempting to inflate them, by inhaling uninflated balloons while sucking or chewing on them, or by inhaling pieces of broken balloons.<sup>37</sup> Between 2001 and 2015, the most recent year for which data are available, approximately 39 percent of all toy-related choking fatalities reported to the CPSC involved balloons.<sup>38</sup> Because balloons are intended for older children, and because of the risks inherent in inflating them, balloons present a serious choking hazard for children significantly older than the typical at-risk population for small parts and balls.

### Federal Standards for Balloons

Balloon packages must display an explicit choke hazard warning. Due to the risk balloons pose even to older children, the warning must explain that the hazard applies to children younger than eight.<sup>39</sup>

The required label is:



**WARNING:**

CHOKING HAZARD--Children under 8 yrs. can choke or suffocate on uninflated or broken balloons. Adult supervision required.

Keep uninflated balloons from children. Discard broken balloons at once.

### Toy Survey Findings: Balloons

Almost all of the balloons packages we inspected in stores included the required warning label, complete with language warning that children under eight can choke on balloons and balloon parts. However, we continue to find balloons marketed to children under eight that also include an indication that the product is

for children ages 3 and older, or contain a second label with a small parts warning that the balloons are not for children under 3 years. This second label can be confusing because a parent can assume that the balloons can be used by children between 3 and 8 years. Additionally, we found one balloon set which did not contain the requisite warning label that children under eight can choke on balloons and balloon parts.

## Magnets

Small, powerful magnets that rose to popularity in the mid-to-late 2000s have the potential to cause serious injury and even death due to complications arising from ingestion. These “rare-earth” magnets are much more powerful than refrigerator magnets. Such magnets are used in various types of toys including construction sets, puzzles, toy jewelry, action figures, board games, and train sets. They are also common in novelty items containing hundreds of small magnetic pieces and previously marketed at adults as sculpture kits, desk toys, or stress relievers. “Buckyballs” – the subject of a recall ordered by the CPSC – are perhaps the most well-known example of such a product, with hundreds of small, spherical magnets, each much smaller than a marble, closer in size to a BB pellet.

Despite being marketed as a desk toy for adults, incidents reported to the CPSC made clear that children were nonetheless suffering serious injury after swallowing these magnets, highlighting the risk posed by adult novelty items even with appropriate warning labels.<sup>40</sup> What makes these adult magnet sets so dangerous is that their numerous magnets are easy to lose track of and the products themselves are inherently appealing to children. While very young children may mistake component magnets for candy, older children and young adolescents may use pairs of magnets to imitate facial or tongue pierc-

ings, thus putting magnets in a position to be accidentally inhaled or swallowed.<sup>41</sup> Once in the digestive system, a single magnet may pass through the body without incident. If two or more magnets are swallowed, however, their attractive forces can pull them toward each other, causing obstructions or pinching, or trapping intestinal walls or other digestive tissue.<sup>42</sup> In extreme cases, the magnetic attraction can perforate intestinal walls. In 2013, a 19-month old girl died after seven small magnetic balls perforated her bowel, leading to infection.<sup>43</sup> Even non-fatal magnet-related injuries are severe. Nearly 80 percent of high-powered magnet ingestions require invasive medical intervention, either through an endoscopy, surgery, or both. In comparison, only 10 to 20 percent of other foreign body ingestions require endoscopic intervention and almost none require surgery.<sup>44</sup> Between 2009 and 2013, the CPSC estimates that high-powered magnets caused approximately 2,900 emergency room-treated injuries.<sup>45</sup> A recently published study of magnet-caused injuries at one large pediatric hospital found a significant increase in their incidence between 2002 and 2012.<sup>46</sup> From October 2016 to October 2017, the CPSC recalled two toys for magnet hazards.<sup>47</sup>

## Federal Standards for Magnets

- In September 2014, the CPSC adopted a new rule that powerful magnets, whether sold in sets or individually, must be too large to fit into the official small parts cylinder used by the CPSC to determine choke hazards (see “Choking Hazards” section). Magnets that fit into a choke tube and that exceed the CPSC’s magnetic flux standards are banned for sale. The ban on small, high-powered magnet sets took effect on April 1, 2015.<sup>48</sup>
- The separate ASTM F963 standard for toys bans loose magnets or magnetic



components in toys for children under the age of 14. There is an exception for magnets included in certain “hobby, craft, and science kit-type items” intended for children age eight years and older, provided the products comply with special magnet hazard disclosure requirements.<sup>49</sup> The severity of injuries caused by small, high-powered magnets led to the CPSC’s ban. In 2012, the CPSC sued several manufacturers of small, powerful magnets to stop the distribution of Buckyballs and similar products. The lawsuits argued that warning labels had been ineffective in preventing injuries to children. All but one of the manufacturers, Zen Magnets, had settled with the CPSC by the summer of 2014 and agreed to recall their products.<sup>50</sup> The CPSC subsequently issued a regulatory ban on all similar products because of the risk of injury and death they present.

- However, the regulation was challenged by Zen Magnets and vacated by a divided panel of the 10<sup>th</sup> Circuit, U.S. Court of Appeals, in November 2016.<sup>51</sup> In October 2017, a CPSC administrative law judge, on review of a modified recall order against Zen Magnets, found that certain Zen Magnets do “constitute a substantial product hazard” under the 2014 regulation and reinstated a CPSC “Stop Sale” order.<sup>52</sup>

Zen Magnets has initiated a legal challenge to the order in the U.S. courts. Other manufacturers seek entry in the marketplace.

**Recommendation:** We continue to recommend to all parents that old small powerful magnet sets be placed in plastic bags and thrown away.

## Data-Collecting Toys & FBI Alert

As more and more products become connected to the Internet as part of the “Internet of Things,” data collection, data privacy and the sharing of consumer information become greater concerns. While the collection of and sharing of information about adults and teenagers is lightly regulated in the United States, the collection and subsequent use of information about children under 13 is governed by the Children’s Online Privacy Protection Act (COPPA) of 1998. The act is enforced by the Federal Trade Commission (FTC), which has brought at least 28 actions against websites and firms for COPPA violations.<sup>53</sup> In June, the FTC confirmed that “connected-toys” are subject to COPPA.<sup>54</sup>

In July, the U.S. Federal Bureau of Investigation (FBI) issued a stark warning to parents:

The FBI encourages consumers to consider cyber security prior to introducing smart, interactive, internet-connected toys into their homes or trusted environments. [...] In some cases, toys with microphones could record and collect conversations within earshot of the device. Information such as the child’s name, school, likes and dislikes, and activities may be disclosed through normal conversation with the toy or in the surrounding environment. The collection of a child’s personal information combined with a toy’s ability to connect to the Internet or other devices raises concerns for privacy and physical safety. Personal information (e.g., name, date of birth, pictures, address) is typically provided when creating user accounts. In addition, companies collect large amounts of additional data, such as voice mes-

sages, conversation recordings, past and real-time physical locations, Internet use history, and Internet addresses/IPs.<sup>55</sup>

The number of connected products grows daily. Websites, mobile apps and products, including children's watches and toys, are all capable of collecting information about and tracking users, including children under 13.

As an example of a toy that may pose privacy problems, we list a popular doll, "My Friend Cayla." The doll has been banned in Germany<sup>56</sup> for privacy violations and is the subject of a complaint by several consumer groups to the U.S. Federal Trade Commission because it may violate the Children's Online Privacy Protection Act. The toy's manufacturer is Genesis Toys; the consumer complaint to the FTC is targeted at both Genesis and its software partner Nuance Communications. According to the complaint, the doll is intended for children 4 and up.<sup>57</sup>

The consumer groups allege that the doll has an unsecure Bluetooth connection that does not require a password to connect, meaning that the doll can function as a remote Bluetooth headset, speaker or microphone on any Bluetooth-enabled device, without downloading and using the doll's companion app. We confirmed this.

From their complaint:<sup>58</sup>

11. [...] The physical doll contains a Bluetooth microphone and speaker, and the companion app provides the data processing to facilitate the toy's ability to capture the private communications of children. [...]

65. [...] The dolls do not implement any other security measure to prevent unauthorized Bluetooth pairing.

66. As a result, when the Cayla and i-Que dolls are powered on and not already paired with another device, any

smartphone or tablet within a 50-foot range can establish a Bluetooth connection with the dolls. Users do not have to enter an authentication code or have physical access to the doll in order to establish a connection with the dolls. Users also do not need to have the Cayla or i-Que companion application installed because smartphones identify the doll as a hands-free headset.<sup>59</sup>

The consumer groups also make a variety of allegations that the doll's collection of information violates COPPA. From their complaint:

91. As described above, Genesis operates an online service directed to children via the My Friend Cayla and i-Que Intelligent Robot dolls and companion applications, which collects personal information from children, including audio files of children's voices, and children's names, location, and IP addresses.

92. In connection with the acts and practices described above, Genesis Toys collects personal information from children younger than 13 in violation of COPPA.<sup>60</sup>

We include Cayla in this year's report as an example of just one Internet of Things toy collecting information about children. Recently, we joined a number of consumer groups, including Consumers Union (publisher of Consumer Reports), in a letter to the FTC about certain children's smart watches that may also violate COPPA and may pose other privacy concerns.<sup>61</sup>

Parents interested in learning about COPPA can download a free guide -- Protecting Children's Online Privacy: A Parent's Guide to the new stronger kids' privacy rules for digital media (COPPA) -- published by the non-profit privacy watchdog, the Center for Digital Democracy.<sup>62</sup>

## Excessive Noise

Excessive noise can be harmful; damaging the inner ear and causing hearing loss. Sounds can cause harm by being too loud even for a short period of time, or by being loud over an extended timeframe. Hearing loss from excessive noise exposure is common in the U.S., even for the young. Sixteen percent of teens aged 12 to 19 years have some self-reported hearing loss for which loud noise could be responsible.<sup>63</sup> A 1998 study of children in a wider age range found approximately 15 percent of children between ages six and 17 showed signs of hearing loss.<sup>64</sup>

While the CPSC has not recalled a toy over the past year for noise hazards, excessive noise in toys is of concern because children have the most to lose from hearing loss. Loss of hearing at an early age can affect a child's ability to learn vocabulary, grammar, idiomatic expressions, and other aspects of verbal communication.<sup>65</sup> This could have consequences for their educational attainment and social and professional success later in life.

### Federal Standards for Noise Levels

Noise standards have improved in recent years. Toy manufacturers were not required to follow sound standard guidelines until 2009 when federal law gave the CPSC authority to enforce voluntary standards contained in the comprehensive ASTM F963 toy standard.<sup>66</sup>

- Hand-held, tabletop, floor, and crib toys producing continuous sound cannot do so in excess of 85 decibels when measured from approximately 20 inches.<sup>67</sup>
- Close-to-the-ear toys must adhere to a continuous sound limit of 65 decibels when measured from approximately 20 inches.
- Close-to-the-ear toys are subject to a limit of 96 decibels for bursts of noise when measured from approximately 20 inches.
- All other toys are subject to a limit of 115 decibels for bursts of noise, except toys using an explosive action or percussion cap, which are limited to 125 decibels. As with all sound standards, these are noise levels as measured at approximately 20 inches.

## Overheating of Batteries and Chargers

In the United States, burns and fires are leading causes for unintentional deaths and injuries to children.<sup>68</sup> From October 2016 to October 2017, the CPSC recalled six toys due to overheating which can lead to fire and burn hazards.<sup>69</sup> Hoverboards remain a popular item that continue to be recalled because certain models contain lithium-ion battery packs that could overheat, which could lead to the products smoking, catching fire, or even exploding.<sup>70</sup>

# Recommendations

**P**olicymakers should continue building upon recent progress in the strengthening of toy safety standards.

- Maintain the CPSC's funding and authorities to protect the public; and
- Understand that regulations protect health and safety.

**The CPSC should improve recall effectiveness:**

- Engage in efforts to increase consumer and researcher awareness of the public hazard database [SaferProducts.gov](http://SaferProducts.gov);
- Aggressively seek to increase recall effectiveness by making sellers agree to conduct more effective outreach campaigns that stress the real hazard posed, rather than simply promote the purported good will of the firm;
- Perform regular online sweeps checking for the availability of previously-recalled toys; and
- Hold companies reselling recalled products accountable, which also sends a message to others.

**The CPSC should continue to enforce and improve strong safety standards:**

- Continue to vigorously enforce the Consumer Product Safety Improvement Act's mandatory standards for toys, including strict limits on lead and lead paint in any toys, jewelry or other articles for children under 12 years;
- Vigorously enforce the Consumer Product Safety Improvement Act's permanent ban on the use of three specific phthalates in all toys and children's products;
- Enlarge the small parts test tube to be more protective of children under three;
- Change the small-ball rule to include small round or semi-round objects, and not just "balls" in the strictest definition, since these toys pose the same hazards as small balls (this is especially true of rounded toy food, since it is "intended" to be eaten);
- Enforce the use of the United States' statutory choke hazard warning label, as many toys now are wrongly labeled with less explicit foreign warnings; and

- Continue to enforce CPSC rules requiring online warning labels.
  - Classify all fidget spinners as toys and hold them to federal standards for children's products.
- Parents and caregivers can also take steps to protect children from potential hazards. We recommend that parents:**
- Subscribe to email recall updates from the CPSC and other U.S. government safety agencies available at [www.recalls.gov](http://www.recalls.gov);
  - Shop with U.S. PIRG Education Fund's Toy Safety Tips, available at [toysafety-tips.org](http://toysafety-tips.org);
  - Examine toys carefully for hazards before purchase – and don't trust that they are safe just because they are on a store shelf. Check the CPSC recall database at [CPSC.gov](http://CPSC.gov) before buying toys online;
  - Report unsafe toys or toy-related injuries to the CPSC at [Saferproducts.gov](http://Saferproducts.gov);
  - Remember, toys on our list are presented as examples of previously recalled toys only. Other hazards may exist;
  - Review the recalled toys list in this report and compare it to toys in your children's toy boxes;
  - Put small parts, or toys broken into small parts, out of reach. Regularly check that toys appropriate for your older children are not left within reach of children who still put things in their mouths;
  - Eliminate small magnet hazards from your home; and
  - Be aware that that toys connected to the Internet, as well as apps and websites, may be collecting information about children inappropriately. Learn more about the Children's Online Privacy Protection Act (COPPA).

# CPSC-Recalled Toys from October 20, 2016 to October 5, 2017

<b>Name of Toy</b>	<b>Halloween LED Gel Clings</b>
<b>Distributor</b>	Target Corp., of Minneapolis, Minn.
<b>Original Dates of Sale</b>	August 2016 through September 2016
<b>Original Price before Recall</b>	\$1
<b>Why Toy is a Hazard</b>	The gel clings can separate and expose the inner decal and LED/button battery compartment, posing choking and button battery ingestion hazards to children.
<b>Remedy</b>	Consumers should immediately remove the recalled gel clings from areas with children and return them to any Target store for a full refund.
<b>How to Tell if Your Toy Might Have Been Recalled</b>	Model number 234-25-0904 is printed on the gel cling's packaging.
<b>CPSC Recall Website</b>	<a href="https://www.cpsc.gov/Recalls/2017/Target-Recalls-Halloween-LED-Gel-Clings#">https://www.cpsc.gov/Recalls/2017/Target-Recalls-Halloween-LED-Gel-Clings#</a>
<b>Recall Date</b>	10/20/16
<b>Number of Units Recalled</b>	127,000
<b>Incidents/Injuries</b>	None reported

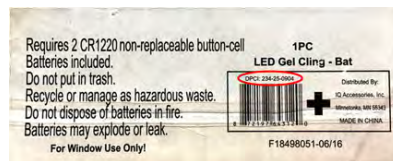

<b>Name of Toy</b>	<b>Peg Perego's 850 Polaris Sportsman Ride-on Vehicle</b>
<b>Importer</b>	Peg Perego USA, of Fort Wayne, Ind.
<b>Original Dates of Sale</b>	October 2014 through April 2016
<b>Original Price Before Recall</b>	\$500 - \$600
<b>Why Toy is a Hazard</b>	A relay on the circuit board can fail causing the vehicle's motor to overheat and ignite, posing fire and burn hazards.
<b>Remedy</b>	Consumers should immediately stop children from using the recalled toy vehicles and contact Peg Perego to receive a free replacement circuit board with instructions, including shipping. Consumers can also access the installation instructions on the firm's website. Peg Perego is contacting known customers directly.
<b>How to Tell if Your Toy Might Have Been Recalled</b>	This recall involves Peg Perego's 850 Polaris Sportsman ride-on, 24-volt battery operated toy vehicles intended for children ages 5 to 7 years. The ATV-style vehicles for two people are silver, red and black and have four wheels, a flip-up backrest for the back passenger and a front and rear luggage rack. Vehicles with date codes 651016, 651017, 651020, 651021, 651022, 651023, 651024, 651027, 651028, 651029, 651030, 660304, 660305, 661123, 661124, 661125 and 661130 are included in this recall. The date code can be found underneath the vehicle seat. Sportsman Twin and 850 EFI appear on the side of the ride-on vehicle and Polaris appears on the side of the vehicle's seat.
<b>CPSC Recall Website</b>	<a href="https://www.cpsc.gov/Recalls/2017/Peg-Perego-Recalls-Childrens-Ride-On-Vehicles#">https://www.cpsc.gov/Recalls/2017/Peg-Perego-Recalls-Childrens-Ride-On-Vehicles#</a>
<b>Recall Date</b>	10/27/16
<b>Number of Units Recalled</b>	3,000
<b>Incidents/Injuries</b>	Peg Perego has received three reports of the children's ride-on toy vehicles overheating, including one report of a burn.



<b>Name of Toy</b>	<b>Lexibook Baby Bath Seats and Chairs</b>
<b>Distributor</b>	Lexibook S.A., of France
<b>Original Dates of Sale</b>	January 2013 through August 2016
<b>Original Price Before Recall</b>	\$30 - \$60
<b>Why Toy is a Hazard</b>	The bath seats/chairs fail to meet the federal safety standard, including requirements for stability and the bath seats can tip over while a baby is in it, posing a drowning hazard to babies.
<b>Remedy</b>	Consumers should immediately stop using the recalled baby bath seats and contact the online retailer where it was purchased for return instructions and to receive a full refund, or a refund in the form of a store credit or gift card, depending on the online retailer. All known purchasers will be contacted directly about the recall.
<b>How to Tell if Your Toy Might Have Been Recalled</b>	This recall includes all Lexibook Baby Bath Seats and Chairs. The plastic baby bath seats/chairs are intended for children 6 months and up. They have a plastic base with suction cups on the bottom, a back/arm support and a toy tray. "Lexibook" is stamped on the back/arm support. "Made in China" and "2014 Lexibook Limited IT028/IT029 SN: 1407/VA09" are stamped on the bottom of the base. They were sold in a variety of colors.
<b>CPSC Recall Website</b>	<a href="https://www.cpsc.gov/Recalls/2017/Baby-Bath-Seats-Chairs">https://www.cpsc.gov/Recalls/2017/Baby-Bath-Seats-Chairs</a>
<b>Recall Date</b>	12/1/16
<b>Number of Units Recalled</b>	7,000
<b>Incidents/Injuries</b>	None reported





<b>Name of Toy</b>	<b>Orbit Self-balancing Scooters/Hoverboards</b>
<b>Distributor</b>	World Trading, of Valencia, Calif.
<b>Original Dates of Sale</b>	December 2015
<b>Original Price Before Recall</b>	\$300
<b>Why Toy is a Hazard</b>	The lithium-ion battery packs in the self-balancing scooters/hoverboards can overheat, posing a risk of smoking, catching fire and/or exploding.
<b>Remedy</b>	Consumers should immediately stop using these recalled products and contact World Trading to exchange their hoverboard for a free UL-certified replacement hoverboard.
<b>How to Tell if Your Toy Might Have Been Recalled</b>	This recall involves Orbit brand self-balancing scooters/hoverboards. The hoverboards have two wheels at either end of a platform and are powered by lithium ion battery packs. Orbit brand hoverboards were sold in the following six colors: black, blue, gold, green, red and white. "Orbit" is printed on a black sticker on the underside of the hoverboard.
<b>CPSC Recall Website</b>	<a href="https://www.cpsc.gov/Recalls/2017/World-Trading-Recalls-Orbit-Self-Balancing-Scooters-and-Hoverboards">https://www.cpsc.gov/Recalls/2017/World-Trading-Recalls-Orbit-Self-Balancing-Scooters-and-Hoverboards</a>
<b>Recall Date</b>	12/13/16
<b>Number of Units Recalled</b>	1,900
<b>Incidents/Injuries</b>	None reported



<b>Name of Toy</b>	<b>Bump 'N Go Walking Egg Laying Chicken with Light, Sound and Music</b>
<b>Importer</b>	Bingo Deals
<b>Original Dates of Sale</b>	July 2015 through June 2016
<b>Original Price Before Recall</b>	\$20
<b>Why Toy is a Hazard</b>	The toys contain small eggs and the chicken can break into small plastic pieces, both posing a choking hazard to children.
<b>Remedy</b>	Consumers should immediately take the chicken toy and eggs away from children and contact Bingo Deals for a full refund. Bingo Deals is contacting consumers who bought the toy directly.
<b>How to Tell if Your Toy Might Have Been Recalled</b>	This recall involves the Bump 'N Go Walking Egg Laying Chicken with light, sound and music. The battery-powered plastic toy is a yellow chicken with an orange head and orange wings. The chicken toy includes three white plastic eggs that are placed into the back of the chicken and then released from the bottom. The chicken measures 7 inches wide by 6 inches tall by 7 inches deep. The eggs measure one inch wide by one inch tall by one inch deep. "QQ Chicken" is printed on the wing. A small yellow chicken sits on the chicken's back.
<b>CPSC Recall Website</b>	<a href="https://www.cpsc.gov/Recalls/2017/Chicken-Toys-Recalled-by-Bingo-Deals#">https://www.cpsc.gov/Recalls/2017/Chicken-Toys-Recalled-by-Bingo-Deals#</a>
<b>Recall Date</b>	12/13/16
<b>Number of Units Recalled</b>	2,700
<b>Incidents/Injuries</b>	None reported



<b>Name of Toy</b>	<b>Joyrider Three-Wheeled Scooters</b>
<b>Importer</b>	Glopo Inc, South El Monte, Calif.
<b>Original Dates of Sale</b>	June 2014 through January 2016
<b>Original Price Before Recall</b>	\$50 - \$80
<b>Why Toy is a Hazard</b>	The front wheels of the children’s scooter can detach when riding, posing a fall hazard.
<b>Remedy</b>	Consumers should immediately stop using recalled scooters and contact GLOPO for instructions on receiving a free repair kit.
<b>How to Tell if Your Toy Might Have Been Recalled</b>	This recall involves Joyrider three-wheeled scooters for children. They have a low, foot-gripping deck, multicolored handgrips, and an adjustable metal T-bar handle. The scooters are made of metal and plastic and come in a variety of colors. The tracking label sticker can be found on the back of the scooter, with batch PO number of G20140423. Recalled model numbers are: GT5048R, GT5110R, GT5121R, GT5124R, GT5125R, GT5122R, GT5117R, GT5123R. Model numbers can be found on the bottom of the scooter base, on the receipt and on the packaging.
<b>CPSC Recall Website</b>	<a href="https://www.cpsc.gov/Recalls/2017/GLOPO-Recalls-Childrens-Scooters">https://www.cpsc.gov/Recalls/2017/GLOPO-Recalls-Childrens-Scooters</a>
<b>Recall Date</b>	12/29/16
<b>Number of Units Recalled</b>	520
<b>Incidents/Injuries</b>	GLOPO has received one report of the front wheels detaching from the scooter, resulting in an injury to a child who fell off the scooter.



<b>Name of Toy</b>	<b>2nd Generation Boosted Dual+ electric skateboards with lithium ion battery packs</b>
<b>Importer</b>	Boosted Inc., of Mountain View, Calif.
<b>Original Dates of Sale</b>	September 2016 through November 2016
<b>Original Price before Recall</b>	\$1,500
<b>Why Toy is a Hazard</b>	The lithium ion battery pack of the electric-powered skateboards can overheat and smoke, posing a fire hazard.
<b>Remedy</b>	Consumers should immediately stop using the recalled skateboards and contact Boosted for a free replacement battery pack.
<b>How to Tell if Your Toy Might Have Been Recalled</b>	This recall involves 2nd Generation Boosted Dual+ electric skateboards with lithium ion battery packs. "Boosted" is printed on the wooden skateboards. Serial numbers that start with S2634 through S2644 are located on a white sticker on the bottom of the boards. The battery packs were sold as original equipment with the skateboards and are attached to the bottom of the board in a black thermoplastic enclosure. Model number B2SR and "Boosted Lithium" are printed on the battery pack. The battery packs have an orange power button.
<b>CPSC Recall Website</b>	<a href="https://www.cpsc.gov/Recalls/2017/Boosted-Recalls-Electric-Skateboards">https://www.cpsc.gov/Recalls/2017/Boosted-Recalls-Electric-Skateboards</a>
<b>Recall Date</b>	1/12/17
<b>Number of Units Recalled</b>	3,200
<b>Incidents/Injuries</b>	Boosted has received two reports of the battery packs overheating and smoking. No injuries have been reported.



<b>Name of Toy</b>	<b>RH Baby &amp; Child Vintage Race Car Mobiles</b>
<b>Importer</b>	Restoration Hardware (RH), of Corte Madera, Calif.
<b>Original Dates of Sale</b>	October 2014 through October 2016
<b>Original Price before Recall</b>	\$50
<b>Why Toy is a Hazard</b>	The wheels on the mobile's hanging cars can detach and fall, posing a choking hazard to young children.
<b>Remedy</b>	Consumers should immediately stop using the recalled mobiles, place away from children and contact RH Baby & Child for a full refund. The firm is contacting purchasers of the product directly.
<b>How to Tell if Your Toy Might Have Been Recalled</b>	This recall involves RH Baby & Child vintage race car mobiles. The recalled mobiles are used as decorative items that hang from the ceiling. The mobiles contain six wooden cars in various colors with spinning axles and wooden wheels attached to the axles.
<b>CPSC Recall Website</b>	<a href="https://www.cpsc.gov/Recalls/2017/RH-Baby-and-Child-Recalls-Mobiles">https://www.cpsc.gov/Recalls/2017/RH-Baby-and-Child-Recalls-Mobiles</a>
<b>Recall Date</b>	1/17/17
<b>Number of Units Recalled</b>	1,000
<b>Incidents/Injuries</b>	RH has received one report of a wheel detaching from the mobile. No injuries have been reported.

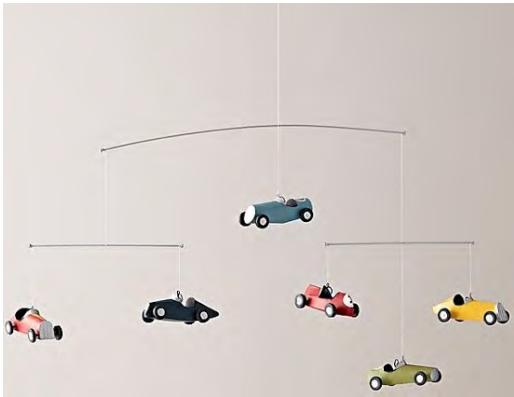

<b>Name of Toy</b>	<b>Pulse Safe Start Transform Electric Scooters</b>
<b>Importer</b>	Target Corp., of Minneapolis, Minn.
<b>Original Dates of Sale</b>	October 2016 through November 2016
<b>Original Price before Recall</b>	\$100
<b>Why Toy is a Hazard</b>	The knuckle that joins the wheel of the children's electric scooters to the axle can break, posing a fall hazard to the rider.
<b>Remedy</b>	Consumers should immediately take the recalled scooters away from children and contact Pulse Performance Products for a full refund.
<b>How to Tell if Your Toy Might Have Been Recalled</b>	This recall involves Pulse Safe Start Transform electric scooters for children with manufacturing date codes between September 10, 2016 and October 11, 2016. The date code is printed on a label located under the platform in format XX(month)/XX(day)/2016 – 066QY. The scooters were sold in blue and have two wheels in front and one in the rear.
<b>CPSC Recall Website</b>	<a href="https://www.cpsc.gov/Recalls/2017/Pulse-Performance-Recalls-Childrens-Electric-Scooters">https://www.cpsc.gov/Recalls/2017/Pulse-Performance-Recalls-Childrens-Electric-Scooters</a>
<b>Recall Date</b>	1/24/17
<b>Number of Units Recalled</b>	8,900
<b>Incidents/Injuries</b>	None reported

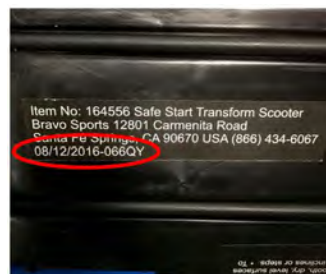

<b>Name of Toy</b>	<b>Happy Holidays! Mickey Mouse Nightlight</b>
<b>Importer</b>	Disney Destinations, LLC, d/b/a Disney Theme Park Merchandise, of Lake Buena Vista, Fla.
<b>Original Dates of Sale</b>	July 2016 through November 2016
<b>Original Price before Recall</b>	\$15
<b>Why Toy is a Hazard</b>	Liquid from the nightlight can leak onto the electrical outlet, posing a fire hazard.
<b>Remedy</b>	Consumers should immediately stop using the recalled nightlights and contact Walt Disney Parks and Resorts US, Inc. for instructions on returning them for a full refund.
<b>How to Tell if Your Toy Might Have Been Recalled</b>	This recall involves the Happy Holidays! Mickey Mouse Nightlight with a Mickey Mouse face and red and white Santa hat filled with liquid and glitter. The date code FAC # 019808-16150 is printed on the bottom rear of the nightlight. The UPC code, 400009489637, is printed on a sticker on the bottom of the product packaging.
<b>CPSC Recall Website</b>	<a href="https://www.cpsc.gov/Recalls/2017/Walt-Disney-Parks-and-Resorts-Recalls-Mickey-Mouse-Nightlights">https://www.cpsc.gov/Recalls/2017/Walt-Disney-Parks-and-Resorts-Recalls-Mickey-Mouse-Nightlights</a>
<b>Recall Date</b>	2/2/17
<b>Number of Units Recalled</b>	3,000
<b>Incidents/Injuries</b>	Walt Disney Parks and Resorts have received two reports of incidents, including one electrical fire. No injuries have been reported.



<b>Name of Toy</b>	<b>Mickey Mouse and Minnie Mouse Light-spinner Wands</b>
<b>Importer</b>	Feld Entertainment Inc., of Vienna, Va.
<b>Original Dates of Sale</b>	October 2016 through November 2016
<b>Original Price before Recall</b>	\$22
<b>Why Toy is a Hazard</b>	The top component of the light-spinner toy wands can detach and expose an 8-inch metal rod, posing an injury hazard to young children.
<b>Remedy</b>	Consumers should immediately stop using the recalled wands and contact Feld Entertainment to receive a full refund.
<b>How to Tell if Your Toy Might Have Been Recalled</b>	This recall involves light-spinner wands with lot numbers 954544 and 954603 imprinted on the bottom of the toy. The light-spinner wands have either Mickey Mouse or Minnie Mouse at the top. The Mickey Mouse wands are yellow, red and black. The Minnie Mouse wands are pink, white and blue. The wands measure about 18 inches tall.
<b>CPSC Recall Website</b>	<a href="https://www.cpsc.gov/Recalls/2017/Feld-Entertainment-Recalls-Toy-Wands-Due">https://www.cpsc.gov/Recalls/2017/Feld-Entertainment-Recalls-Toy-Wands-Due</a>
<b>Recall Date</b>	2/9/17
<b>Number of Units Recalled</b>	30,100
<b>Incidents/Injuries</b>	None reported





<b>Name of Toy</b>	<b>Little Live Pets Lil Frog and Lil Frog Lily Pad toys</b>
<b>Importer</b>	Regal Logistics, of Fife, Wash.
<b>Manufacturer</b>	Moose Toys Proprietary Ltd., of Australia
<b>Original Dates of Sale</b>	August 2016 through February 2017
<b>Original Price before Recall</b>	\$15 - \$25
<b>Why Toy is a Hazard</b>	When the button batteries are removed from the toy frogs, the battery's cap can become a projectile and the battery's chemicals can leak, posing chemical and injury hazards.
<b>Remedy</b>	Consumers should immediately stop using the toy frogs, refrain from opening the battery compartment and contact Moose Toys for a free replacement Little Live Pet product.
<b>How to Tell if Your Toy Might Have Been Recalled</b>	This recall involves the Little Live Pets Lil Frog plastic toys. They operate with four button batteries and jump. Little Live Pets Lil Frog has SKU: 28217 and Lil Frog Lily Pad has SKU: 28218 printed on the frog's lower belly near its left thigh with a manufacture date code under it. The date code range is WS112016 to WS123216. The toy frogs were sold in pink, blue and green colors.
<b>CPSC Recall Website</b>	<a href="https://www.cpsc.gov/Recalls/2017/Moose-Toys-Recalls-Toy-Frogs">https://www.cpsc.gov/Recalls/2017/Moose-Toys-Recalls-Toy-Frogs</a>
<b>Recall Date</b>	2/22/17
<b>Number of Units Recalled</b>	427,000
<b>Incidents/Injuries</b>	The firm has received 17 reports of the battery's cap becoming a projectile or battery chemicals leaking, including two injuries that resulted in emergency room and doctor's office visits for eye irritation from the battery chemicals.



<b>Name of Toy</b>	<b>Little Tikes 2-in-1 Snug 'n Secure Pink Toddler Swings</b>
<b>Manufacturer</b>	Little Tikes, of Hudson, Ohio
<b>Original Dates of Sale</b>	November 2009 through May 2014
<b>Original Price before Recall</b>	\$25
<b>Why Toy is a Hazard</b>	The plastic seat can crack or break, posing a fall hazard.
<b>Remedy</b>	Consumers should immediately stop using the recalled swings and contact Little Tikes for a refund in the form of a credit towards the purchase of another Little Tikes product.
<b>How to Tell if Your Toy Might Have Been Recalled</b>	This recall involves Little Tikes 2-in-1 Snug'n Secure pink toddler swings. The swings have a pink T-shaped restraint in front with a Little Tikes logo. The swing is suspended by four yellow ropes. The model number 615573 is molded on the back of the swing seat and there is a manufacturing date code stamp on the back of the seat. The molded INNER arrow of the date code stamp points to "10", "11", "12" or "13", it is included in the recall. In addition, swings with a date code stamp of "9" on the INNER arrow combined with "43" or higher number stamped on the OUTER are included in this recall. No other date codes or other colored swings are affected.
<b>CPSC Recall Website</b>	<a href="https://www.cpsc.gov/Recalls/2017/Little-Tikes-Recalls-Toddler-Swings">https://www.cpsc.gov/Recalls/2017/Little-Tikes-Recalls-Toddler-Swings</a>
<b>Recall Date</b>	2/23/17
<b>Number of Units Recalled</b>	540,000
<b>Incidents/Injuries</b>	The firm has received about 140 reports of the swing breaking, including 39 injuries to children including abrasions, bruises, cuts and bumps to the head. Two of the reported injuries included children with a broken arm.



<b>Name of Toy</b>	<b>Kids II Oball Rattles</b>
<b>Importer</b>	Kids II Inc., of Atlanta, Ga.
<b>Original Dates of Sale</b>	January 2016 through February 2017
<b>Original Price before Recall</b>	\$5 - \$7
<b>Why Toy is a Hazard</b>	The clear plastic disc on the outside of the oball rattles can break, releasing small beads, posing a choking hazard to young children.
<b>Remedy</b>	Consumers should immediately take these recalled rattles away from young children and contact the firm to receive a full refund.
<b>How to Tell if Your Toy Might Have Been Recalled</b>	This recall involves Oball Rattles in pink, blue, green and orange with model number 81031 printed on the inner surface of one of the plastic discs and on the packaging. The balls have 28 finger holes and measure four inches in diameter. Embedded in the rattles are a clear plastic disc with all orange beads and two clear plastic discs with beads of varying colors on the perimeter. Only rattles with date codes T0486, T1456, T2316, T2856 and T3065 located on a small triangle on the inner surface of the rattle are included in the recall. The first three numbers represent the day of the year and the last digit represents the year of production.
<b>CPSC Recall Website</b>	<a href="https://www.cpsc.gov/Recalls/2017/Kids-II-Recalls-Oball-Rattles">https://www.cpsc.gov/Recalls/2017/Kids-II-Recalls-Oball-Rattles</a>
<b>Recall Date</b>	3/2/17
<b>Number of Units Recalled</b>	680,000
<b>Incidents/Injuries</b>	The firm has received 42 reports of the plastic disc breaking releasing small beads including two reports of beads found in children's mouths and three reports of gagging.



<b>Name of Toy</b>	<b>Vecaro Glide65, Drift8, and Trek10 Self-balancing Scooter/Hoverboard</b>
<b>Manufacturer</b>	Vecaro LifeStyle, of Cerritos, Calif.
<b>Original Dates of Sale</b>	November 2015 through November 2016
<b>Original Price before Recall</b>	\$300 - \$400
<b>Why Toy is a Hazard</b>	The lithium-ion battery packs in the self-balancing scooters/hoverboards can overheat, posing a risk of smoking, catching fire and/or exploding.
<b>Remedy</b>	Consumers should immediately stop using these recalled scooters/hoverboards and contact Vecaro to return their unit to receive a free repair or a credit toward the purchase of a UL 2272 certified Vecaro Glide or Glide-X.
<b>How to Tell if Your Toy Might Have Been Recalled</b>	This recall involves the Vecaro brand Glide65, Drift8, and Trek10 self-balancing scooter, commonly referred to as hoverboards. Hoverboards have one wheel at each end of a platform and are powered by lithium-ion battery packs. The boards have "Vecaro" printed on the front outer casing and come in black, white, red, blue, metallic gold, metallic silver, graffiti white print, and red flame print. The model number is on the right for both the Glide65 and Drift8. The Trek10 model number is on top of the board.
<b>CPSC Recall Website</b>	<a href="https://www.cpsc.gov/Recalls/2017/Vecaro-LifeStyle-Recalls-Self-Balancing-Scooters-Hoverboards">https://www.cpsc.gov/Recalls/2017/Vecaro-LifeStyle-Recalls-Self-Balancing-Scooters-Hoverboards</a>
<b>Recall Date</b>	3/23/17
<b>Number of Units Recalled</b>	500
<b>Incidents/Injuries</b>	Vecaro has received three reported incidents of hoverboards smoking. No injuries or property damage have been reported.



<b>Name of Toy</b>	<b>Target Magnetic Tic Tac Toe Games</b>
<b>Importer</b>	Target Corp., of Minneapolis, Minn.
<b>Original Dates of Sale</b>	December 2016 through February 2017
<b>Original Price before Recall</b>	\$5
<b>Why Toy is a Hazard</b>	The magnets can come off the tic tac toe game pieces, posing a choking hazard. In addition, when two or more magnets are swallowed, they can link together inside the intestines and clamp onto body tissues, causing intestinal obstructions, perforations, sepsis and death. Internal injury from magnets can pose serious lifelong health effects.
<b>Remedy</b>	Consumers should immediately stop using the recalled tic tac toe game and return it to any Target store for a full refund.
<b>How to Tell if Your Toy Might Have Been Recalled</b>	This recall involves a magnetic tic tac toe 10 x 10 inch plywood board with nine "X" and "Heart" game pieces. The game pieces have a magnet on the back. Model number "234-25-1089" is printed on the bottom right corner of the product.
<b>CPSC Recall Website</b>	<a href="https://www.cpsc.gov/Recalls/2017/Target-Recalls-Magnetic-Tic-Tac-Toe-Games">https://www.cpsc.gov/Recalls/2017/Target-Recalls-Magnetic-Tic-Tac-Toe-Games</a>
<b>Recall Date</b>	3/29/17
<b>Number of Units Recalled</b>	19,000
<b>Incidents/Injuries</b>	Target has received one report of the magnets falling off the game piece. No injuries have been reported.



<b>Name of Toy</b>	<b>Juratoys Toy Trolleys</b>
<b>Importer</b>	Juratoys U.S. of Fairfield, N.J.
<b>Original Dates of Sale</b>	September 2012 to March 2017
<b>Original Price before Recall</b>	\$70 - \$100
<b>Why Toy is a Hazard</b>	The toy trolleys can tip backwards, posing an impact injury hazard to children.
<b>Remedy</b>	Consumers should immediately stop using the recalled trolleys and keep them out of the reach of young children until they have installed a repair kit. Contact Juratoys for a free repair kit that includes instructions, tools, and footers to prevent the toy from tipping backwards.
<b>How to Tell if Your Toy Might Have Been Recalled</b>	This recall involves four Bricolo by Janod® -push toy trolleys. The French Cocotte Cooker trolley is red with orange wheels and includes a cooktop with fried egg shapes, an oven and eight accessories, including pots and pans “Janod” printed on the side and front of the trolley and J06544 printed on the base of the toy. The DIY-Magnetic trolley is gray and black with red wheels with work station and tools. “Bricolo” is printed on the front of the DIY-Magnetic trolley and J06505 is printed on the base of the toy. The Redmaster-Magnetic DIY trolley is black and gray with red wheels and 21 accessories, including three magnetic tools and a set of gears. J06493 is printed on the base of the toy. The Barbecue trolley is brightly colored and comes with a magnetic spatula, magnetic barbecue fork, one piece of pork, two sausages, one fish, one piece of beef, and three tomatoes. J06523 is printed on the base of the toy. The trolleys measure approximately 17 inches tall and have a 1 foot by 1 foot base.
<b>CPSC Recall Website</b>	<a href="https://www.cpsc.gov/Recalls/2017/Juratoys-Recalls-Toy-Trolleys">https://www.cpsc.gov/Recalls/2017/Juratoys-Recalls-Toy-Trolleys</a>
<b>Recall Date</b>	3/29/17
<b>Number of Units Recalled</b>	9,900
<b>Incidents/Injuries</b>	Juratoys has received two reports of trolleys falling backwards, both resulting in ER visits. One involved a tooth extraction the other a laceration to the child’s nose.



<b>Name of Toy</b>	<b>Water-Absorbing Easter and Dino Toys</b>
<b>Importer</b>	Target Corp., of Minneapolis, Minn.
<b>Original Dates of Sale</b>	February 2017 through March 2017
<b>Original Price before Recall</b>	\$1
<b>Why Toy is a Hazard</b>	If the small toy is ingested, it can expand inside a child's body and cause intestinal obstructions, resulting in severe discomfort, vomiting, dehydration and could be life threatening. Surgery is required to remove the toy from the body, if ingested. Medical professionals and parents should be aware that there is a possibility that the toys might not show up on an x-ray.
<b>Remedy</b>	Consumers should immediately take this recalled toy away from children and return it to any Target store for a full refund.
<b>How to Tell if Your Toy Might Have Been Recalled</b>	This recall involves Hatch & Grow Easter Eggs, Easter Grow Toys and Hatch Your Own Dino. Hatch & Grow Easter Eggs and Easter Grow Toys have model number 234-25-1200 on the back of the product's packaging. Hatch Your Own Dino Egg has model number 234-09-0016 on the label inserted in the product's packaging. The pink, blue, or purple Hatch & Grow Easter Eggs include a white bunny, brown bunny, or butterfly. The Easter Grow Toys include a yellow chick, brown bunny, or white bunny. The Hatch Your Own Dino Eggs are purple or yellow/green and contains one of eleven dinosaurs.
<b>CPSC Recall Website</b>	<a href="https://www.cpsc.gov/Recalls/2017/Target-Recalls-Water-Absorbing-Toys">https://www.cpsc.gov/Recalls/2017/Target-Recalls-Water-Absorbing-Toys</a>
<b>Recall Date</b>	4/13/17
<b>Number of Units Recalled</b>	560,000
<b>Incidents/Injuries</b>	None reported.



<b>Name of Toy</b>	<b>Razor RipStik Electric Motorized Caster Boards</b>
<b>Importer</b>	Razor USA LLC, of Cerritos, Calif.
<b>Original Dates of Sale</b>	February 2016 through April 2017
<b>Original Price before Recall</b>	\$180
<b>Why Toy is a Hazard</b>	The rear wheel can stop rotating and lock up while in use, posing a fall hazard.
<b>Remedy</b>	Consumers should immediately stop using the recalled caster boards and contact Razor to receive a free repair kit.
<b>How to Tell if Your Toy Might Have Been Recalled</b>	This recall involves Razor RipStik electric motorized caster boards. The boards have two wheels, a hub motor and a lithium ion battery. They have a wireless digital hand remote that controls the speed up to 10 mph. The manufacturing date is on the bar code label located on the bottom of the product and Razor USA LLC is embossed on the bottom. "RipStik" is printed on the top of the board. They are blue and black in color.
<b>CPSC Recall Website</b>	<a href="https://www.cpsc.gov/Recalls/2017/Razor-Recalls-RipStik-Motorized-Caster-Boards">https://www.cpsc.gov/Recalls/2017/Razor-Recalls-RipStik-Motorized-Caster-Boards</a>
<b>Recall Date</b>	4/20/17
<b>Number of Units Recalled</b>	158,000
<b>Incidents/Injuries</b>	Razor has received more than 700 reports of the rear wheel locking up, resulting in four injuries, including one loose tooth and three scrapes and bruises.

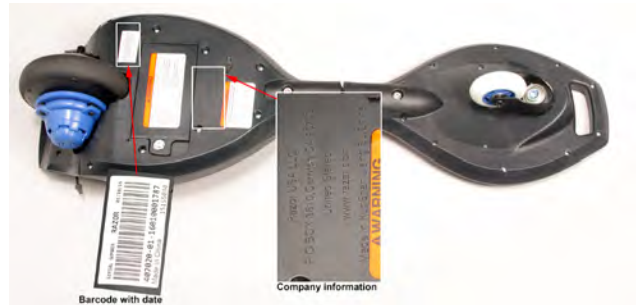



<b>Name of Toy</b>	<b>Douglas Plush Toys</b>
<b>Importer</b>	Douglas Company Inc., of Keene, N.H.
<b>Original Dates of Sale</b>	July 2014 through April 2017
<b>Original Price before Recall</b>	\$20
<b>Why Toy is a Hazard</b>	The plastic eyes on the plush toys can detach, posing a choking hazard.
<b>Remedy</b>	Consumers should immediately take the recalled plush toys away from young children and contact the firm to receive a free replacement product or a full refund.
<b>How to Tell if Your Toy Might Have Been Recalled</b>	This recall involves the Oliver™ the Bear, Chewie™ the English Bulldog, and Charlotte™ the Fox model plush toys. Oliver the Bear is a brown and tan stuffed bear, with a blue t-shirt that reads "Oliver the Bear" and a red, removable cape. Chewie is a stuffed, brown and white English Bulldog with a blue patch sewn on the chest that reads "Chewie." Charlotte is a stuffed, brown, black and white Fox with removable blue cape. Each of these toys has a sewn-in label with the words "DOUGLAS® the cuddle toy."
<b>CPSC Recall Website</b>	<a href="https://www.cpsc.gov/Recalls/2017/Douglas-Recalls-Plush-Toys">https://www.cpsc.gov/Recalls/2017/Douglas-Recalls-Plush-Toys</a>
<b>Recall Date</b>	5/17/17
<b>Number of Units Recalled</b>	25,000
<b>Incidents/Injuries</b>	Douglas has received two reports of the plastic eyes detaching or loosening. No injuries have been reported.



<b>Name of Toy</b>	<b>Pulse Krusher Pro Freestyle Scooters</b>
<b>Importer</b>	Bravo Sports, of Sante Fe Springs, Calif.
<b>Manufacturer</b>	Pulse Performance Products, a division of Bravo Sports, of Santa Fe Springs, Calif.
<b>Original Dates of Sale</b>	June 2016 through May 2017
<b>Original Price before Recall</b>	\$40
<b>Why Toy is a Hazard</b>	The down tube of the scooter can break, posing a fall hazard to the rider.
<b>Remedy</b>	Consumers should immediately stop using the recalled scooters and contact Pulse Performance Products for a full refund.
<b>How to Tell if Your Toy Might Have Been Recalled</b>	This recall involves Pulse Krusher Pro Freestyle scooters with factory code 083WY, item number 164257 and date code 10-8-2016 or earlier. The factory code, item number and date code can be found on a label printed on the underside of the scooter deck. The 30-inch high scooters were sold in blue and have the words "PULSE PERFORMANCE PRODUCTS" printed on the down tube.
<b>CPSC Recall Website</b>	<a href="https://www.cpsc.gov/Recalls/2017/Pulse-Performance-Products-Recalls-Krusher-Scooters">https://www.cpsc.gov/Recalls/2017/Pulse-Performance-Products-Recalls-Krusher-Scooters</a>
<b>Recall Date</b>	5/19/17
<b>Number of Units Recalled</b>	18,700
<b>Incidents/Injuries</b>	The firm has received 15 reports of the down tube breaking, including two reports of scrapes from falls.



<b>Name of Toy</b>	<b>Dynacraft Ride-On Toys</b>
<b>Importer</b>	Dynacraft BSC Inc., of American Canyon, Calif.
<b>Original Dates of Sale</b>	June 2016 through March 2017
<b>Original Price before Recall</b>	\$150 - \$350
<b>Why Toy is a Hazard</b>	The acceleration pedal on the battery-operated ride-on toys can stick, posing fall and crash hazards.
<b>Remedy</b>	Consumers should immediately take the recalled ride-on toys away from children and contact Dynacraft to receive a free replacement foot pedal with installation instructions. Consumers in need of assistance with the repair, can bring the ride-on toy to an authorized service center for a free repair.
<b>How to Tell if Your Toy Might Have Been Recalled</b>	This recall involves three models of 12V battery-operated ride-on toys, including Surge 12V Camo 4X4, Surge 12V XL Quad and Tonka 12V Mighty Dump trucks. The recalled ride-on toys have model numbers and date codes listed in the table below. The model number, batch number, serial number and the date code , formatted as "MMDDYYYY," are printed on a label on the bottom of the ride-on toy.
<b>CPSC Recall Website</b>	<a href="https://www.cpsc.gov/Recalls/2017/Dynacraft-Recalls-Ride-On-Toys">https://www.cpsc.gov/Recalls/2017/Dynacraft-Recalls-Ride-On-Toys</a>
<b>Recall Date</b>	5/23/17
<b>Number of Units Recalled</b>	20,000
<b>Incidents/Injuries</b>	Dynacraft has received 19 reports of pedals sticking, including seven reports of minor injuries; abrasions, cuts and bruises.



<b>Name of Toy</b>	<b>Easter and July 4th Light-Up Spinner Toys</b>
<b>Importer</b>	Hobby Lobby Stores Inc., of Oklahoma City, Okla.
<b>Original Dates of Sale</b>	February 2017 through April 2017
<b>Original Price before Recall</b>	\$5
<b>Why Toy is a Hazard</b>	The battery cover of the Easter and July 4th-themed light-up spinner toys can detach and expose the small coin cell batteries, posing choking and ingestion hazards to young children.
<b>Remedy</b>	Consumers should immediately take the recalled spinners away from children and return them to the nearest Hobby Lobby or Mardel store. Consumers with a receipt will receive a full refund and consumers without a receipt will receive a store credit.
<b>How to Tell if Your Toy Might Have Been Recalled</b>	This recall involves children’s battery-powered, light-up spinner toys sold in two themes: Easter and July 4th. The Easter-themed toys were sold in blue with a pink bunny on the dome and yellow with a yellow and orange chicken on the dome. The July 4th spinners are red with white stars painted on the blue dome. “Hobby Lobby” and item number 9130033 or 9130082 is printed on the spinner handle. The spinners are powered by three LR44 coin cell batteries.
<b>CPSC Recall Website</b>	<a href="https://www.cpsc.gov/Recalls/2017/Hobby-Lobby-Recalls-Easter-and-July-4th-Light-Up-Spinner-Toys">https://www.cpsc.gov/Recalls/2017/Hobby-Lobby-Recalls-Easter-and-July-4th-Light-Up-Spinner-Toys</a>
<b>Recall Date</b>	5/23/17
<b>Number of Units Recalled</b>	43,400
<b>Incidents/Injuries</b>	Hobby Lobby has received one report of a 14-month-old child who ingested the battery. An x-ray was conducted and the battery passed through.



<b>Name of Toy</b>	<b>Munching Max Chipmunk Toys</b>
<b>Importer</b>	TOMY International Inc., of Oak Brook, Ill.
<b>Original Dates of Sale</b>	May 2016 through July 2017
<b>Original Price before Recall</b>	\$16
<b>Why Toy is a Hazard</b>	Parts inside the toy can break creating a sharp point that can penetrate the surface of the toy, posing a laceration hazard.
<b>Remedy</b>	Consumers should immediately take the recalled toys away from children and contact TOMY International to receive a free replacement toy and a TOMY online store coupon.
<b>How to Tell if Your Toy Might Have Been Recalled</b>	This recall involves Lamaze Munching Max chipmunk stuffed toys with item number L27578. "Tomy," "Lamaze" and the item number are printed on a sewn-in fabric label near the tail of the toy. The stuffed toy is multi-colored with a white clip on the head of the chipmunk. When the clip is pulled, the chipmunk toy vibrates and simulates eating the cloth nut attached to its arm.
<b>CPSC Recall Website</b>	<a href="https://www.cpsc.gov/Recalls/2017/TOMY-Recalls-Munching-Max-Chipmunk-Toys">https://www.cpsc.gov/Recalls/2017/TOMY-Recalls-Munching-Max-Chipmunk-Toys</a>
<b>Recall Date</b>	7/13/17
<b>Number of Units Recalled</b>	9,300
<b>Incidents/Injuries</b>	TOMY International has received one report of a minor laceration injury to a child's hand.



<b>Name of Toy</b>	<b>Winkel Colorburst Activity Toys</b>
<b>Importer</b>	The Manhattan Toy Company LLC, of Minneapolis, Minn.
<b>Original Dates of Sale</b>	May 2015 through September 2016
<b>Original Price before Recall</b>	\$15
<b>Why Toy is a Hazard</b>	The colored plastic tubes on the product can become brittle and break into small pieces, posing a choking hazard to infants.
<b>Remedy</b>	Consumers should immediately take the recalled toys away from infants and return it to the store where purchased or contact Manhattan Toy for a full refund.
<b>How to Tell if Your Toy Might Have Been Recalled</b>	The Winkel Colorburst teething and activity toy has multi-color plastic tubing inserted into a plastic cube with rattle beads inside. The model number and lot code are printed on the center of the cube and on the hang-tag and product packaging near the UPC code. Only activity balls with the following lot codes are included in this recall: 206880 DH; 206880 EH; 206880 HH; 206871 EH.
<b>CPSC Recall Website</b>	<a href="https://www.cpsc.gov/Recalls/2017/Manhattan-Toy-Recalls-Activity-Toys">https://www.cpsc.gov/Recalls/2017/Manhattan-Toy-Recalls-Activity-Toys</a>
<b>Recall Date</b>	7/20/17
<b>Number of Units Recalled</b>	14,400
<b>Incidents/Injuries</b>	The firm has received four reports of plastic tubes breaking. No injuries have been reported.



<b>Name of Toy</b>	<b>iRover Self-Balancing Scooters/Hoverboards</b>
<b>Importer</b>	iRover LLC, of Fair Lawn, N.J.
<b>Original Dates of Sale</b>	December 2015 through December 2016
<b>Original Price before Recall</b>	\$300 - \$400
<b>Why Toy is a Hazard</b>	The lithium-ion battery packs in the self-balancing scooters/hoverboards can overheat, posing a risk of smoking, catching fire and/or exploding.
<b>Remedy</b>	Consumers should immediately stop using these recalled scooters/hoverboards and contact iRover for instructions on returning their hoverboard for a free UL2272-certified replacement unit.
<b>How to Tell if Your Toy Might Have Been Recalled</b>	This recall involves iRover self-balancing scooters, commonly referred to as hoverboards, model numbers 87645 and 87644. Hoverboards have two wheels at either end of a platform and are powered by lithium-ion battery packs. The boards have "iRover" printed on the front outer casing and come in black and white. The model number is listed on the bottom of the unit.
<b>CPSC Recall Website</b>	<a href="https://www.cpsc.gov/Recalls/2017/iRover-Recalls-Self-Balancing-Scooters-Hoverboards">https://www.cpsc.gov/Recalls/2017/iRover-Recalls-Self-Balancing-Scooters-Hoverboards</a>
<b>Recall Date</b>	7/24/17
<b>Number of Units Recalled</b>	2,800
<b>Incidents/Injuries</b>	There have been two reports of the battery packs in the recalled self-balancing scooters/hoverboards smoking and overheating. No injuries or property damage have been reported.



<b>Name of Toy</b>	<b>Panelcraft Children's Magnetic Building Sets</b>
<b>Importer</b>	Panelcraft Inc., of Dearborn, Mich.
<b>Original Dates of Sale</b>	November 2016 through January 2017
<b>Original Price before Recall</b>	\$120 - \$150
<b>Why Toy is a Hazard</b>	The building sets corner welds can break, allowing the panels and frames to separate and release magnets during play. When released, exposed magnets can create a choking hazard.
<b>Remedy</b>	Consumers should immediately stop using the recalled building sets and take them away from children. Contact the firm to receive a prepaid shipping label for returning the recalled sets for a free replacement set including shipping.
<b>How to Tell if Your Toy Might Have Been Recalled</b>	This recall involves two styles of Panelcraft™ Rainbow magnetic building sets: Rainbow Dream Builder and Rainbow Solid Builder. The solid builder set includes 19 pieces: 11 solid panels in red, yellow, green, blue and purple and 8 white windows that measure 9 inches by 9 inches. The rainbow dream builder set includes 19 windows in red, yellow, green, blue and purple colors that measure 9 inches by 9 inches.
<b>CPSC Recall Website</b>	<a href="https://www.cpsc.gov/Recalls/2017/Panelcraft-Recalls-Childrens-Building-Sets">https://www.cpsc.gov/Recalls/2017/Panelcraft-Recalls-Childrens-Building-Sets</a>
<b>Recall Date</b>	8/1/17
<b>Number of Units Recalled</b>	2,000
<b>Incidents/Injuries</b>	None reported.





<b>Name of Toy</b>	<b>BRIO Soft Hammer Baby Rattle Toys</b>
<b>Importer</b>	Ravensburger North America, of Newton, N.H.
<b>Manufacturer</b>	BRIO, of Sweden
<b>Original Dates of Sale</b>	March 2015 through June 2017
<b>Original Price before Recall</b>	\$13
<b>Why Toy is a Hazard</b>	The wooden rings on the hammer rattles can crack, posing a choking hazard to children.
<b>Remedy</b>	Consumers should immediately stop using the recalled baby rattles and contact BRIO for instructions on how to receive a full refund or a replacement product of similar value.
<b>How to Tell if Your Toy Might Have Been Recalled</b>	This recall involves BRIO soft hammer baby rattle toys. They have a wooden handle with a white plastic teething ring at one end and a red, yellow, white and green hammer head at the other end. BRIO is stamped on the hammer head. The rattle is about 5 inches long.
<b>CPSC Recall Website</b>	<a href="https://www.cpsc.gov/Recalls/2017/BRIO-Recalls-Baby-Rattles">https://www.cpsc.gov/Recalls/2017/BRIO-Recalls-Baby-Rattles</a>
<b>Recall Date</b>	8/15/17
<b>Number of Units Recalled</b>	1,500
<b>Incidents/Injuries</b>	BRIO has received seven reports of the wooden ring cracking. No injuries have been reported.



<b>Name of Toy</b>	<b>Itty Bittys Baby Plush Stacking Toys</b>
<b>Importer</b>	Hallmark Marketing Company LLC, of Kansas City, Miss.
<b>Original Dates of Sale</b>	June 2016 through July 2017
<b>Original Price before Recall</b>	\$30
<b>Why Toy is a Hazard</b>	The toys have fabric hats and bows that can detach, posing a choking hazard.
<b>Remedy</b>	Consumers should immediately stop using the recalled toys and take them away from children. Contact Hallmark to receive a prepaid shipping label for returning the recalled toy and for a \$40 Hallmark Gold Crown gift card.
<b>How to Tell if Your Toy Might Have Been Recalled</b>	This recall involves the itty bittys baby Disney-licensed plush animal stacking toys with rattling rings. The toys measure 10 inches by 7.5 inches by 9.5 inches. They have a yellow base stand with a post and four rattling rings that slide on and off the post. The red, blue, pink and purple rings have Mickey Mouse and Minnie Mouse, and Donald Duck and Daisy Duck characters attached to them. Three of the four Disney-licensed characters are wearing a small plush, fabric hat or bow. The Hallmark logo and "itty bittys" are printed on a sewn-on tag attached to the toy's base.
<b>CPSC Recall Website</b>	<a href="https://www.cpsc.gov/Recalls/2017/Hallmark-Recalls-Plush-Baby-Stacking-Toys">https://www.cpsc.gov/Recalls/2017/Hallmark-Recalls-Plush-Baby-Stacking-Toys</a>
<b>Recall Date</b>	8/31/17
<b>Number of Units Recalled</b>	5,800
<b>Incidents/Injuries</b>	Hallmark has received one report of the toy's fabric bow detaching. No injuries have been reported.



<b>Name of Toy</b>	<b>Slap Bracelets sold with Trolls Storybooks</b>
<b>Importer</b>	Studio Fun International Inc., of New York
<b>Original Dates of Sale</b>	September 2016 through August 2017
<b>Original Price before Recall</b>	\$13
<b>Why Toy is a Hazard</b>	The metal band can wear through the fabric covering of the slap bracelet, posing a laceration hazard.
<b>Remedy</b>	The recalled "slap bracelets" were included with "DreamWorks Trolls: It's Hug Time!" children's storybooks. The bracelet consists of an inner, flexible metal band wrapped in a purple fabric covering with a pink fabric flower. The ISBN for the book is 978-0-7944-3840-1 and is printed on the back of the book.
<b>How to Tell if Your Toy Might Have Been Recalled</b>	The recalled "slap bracelets" were included with "DreamWorks Trolls: It's Hug Time!" children's storybooks. The bracelet consists of an inner, flexible metal band wrapped in a purple fabric covering with a pink fabric flower. The ISBN for the book is 978-0-7944-3840-1 and is printed on the back of the book.
<b>CPSC Recall Website</b>	<a href="https://www.cpsc.gov/Recalls/2017/Studio-Fun-International-Recalls-Slap-Bracelets-Sold-with-Childrens-Storybooks">https://www.cpsc.gov/Recalls/2017/Studio-Fun-International-Recalls-Slap-Bracelets-Sold-with-Childrens-Storybooks</a>
<b>Recall Date</b>	9/7/17
<b>Number of Units Recalled</b>	79,000
<b>Incidents/Injuries</b>	There have been five reports of the metal bands wearing through the fabric covering of the bracelet resulting in cuts to hands or fingers.



<b>Name of Toy</b>	<b>Playtex Children's Plates and Bowls</b>
<b>Importer</b>	Playtex Products, LLC, of Shelton, Conn.
<b>Original Dates of Sale</b>	October 2009 through August 2017
<b>Original Price before Recall</b>	\$2.50 - \$15
<b>Why Toy is a Hazard</b>	The clear plastic layer over the graphics can peel or bubble from the surface of the plates and bowls, posing a choking hazard to young children.
<b>Remedy</b>	Consumers should immediately stop using the recalled plates and bowls and take them away from young children. Consumers should contact Playtex for a full refund.
<b>How to Tell if Your Toy Might Have Been Recalled</b>	This recall involves Playtex plates and bowls for children. The plates have various printed designs including cars, construction scenes, giraffes, princesses, superheroes and more. The white polypropylene plates and bowls also have a colored rim on top and a non-slip bottom. Playtex is written on the bottom of the plates and bowls. The plates and bowls were sold separately and together as sets. A Mealtime set is comprised of a plate, a bowl, two utensils and a cup.
<b>CPSC Recall Website</b>	<a href="https://www.cpsc.gov/Recalls/2018/Playtex-Recalls-Childrens-Plates-and-Bowls">https://www.cpsc.gov/Recalls/2018/Playtex-Recalls-Childrens-Plates-and-Bowls</a>
<b>Recall Date</b>	10/3/17
<b>Number of Units Recalled</b>	3,600,000
<b>Incidents/Injuries</b>	Playtex has received 372 reports of the clear plastic layer over the graphics bubbling or peeling. The firm has received 11 reports of pieces of the detached clear plastic found in children's mouths, including four reports of choking on a piece of the clear plastic layer.



<b>Name of Toy</b>	<b>Bruin Infant Wiggle Ball toys</b>
<b>Importer</b>	Toys "R" Us Inc., of Wayne, N.J.
<b>Original Dates of Sale</b>	June 2016 through January 2017
<b>Original Price before Recall</b>	\$13
<b>Why Toy is a Hazard</b>	The wiggle ball's rubber knobs and plastic back can detach, posing a choking hazard to infants.
<b>Remedy</b>	Consumers should immediately stop using the recalled balls, take them away from babies and return them to Babies "R" Us or Toys "R" Us for a full refund.
<b>How to Tell if Your Toy Might Have Been Recalled</b>	This recall involves Bruin Infant Wiggle Ball toys also called a giggle ball. The blue ball has textured bumps for gripping and has orange, green and yellow rubber knobs around the ball. The ball wiggles, vibrates and plays three different musical tunes. It has an on/off switch and requires 3 AA batteries to operate. The recalled wiggle balls have model number 5F6342E and Toys "R" Us printed on the product.
<b>CPSC Recall Website</b>	<a href="https://www.cpsc.gov/Recalls/2018/Toys-R-Us-Recalls-Infant-Wiggle-Balls">https://www.cpsc.gov/Recalls/2018/Toys-R-Us-Recalls-Infant-Wiggle-Balls</a>
<b>Recall Date</b>	10/5/17
<b>Number of Units Recalled</b>	29,700
<b>Incidents/Injuries</b>	The firm has received six reports of rubber knobs breaking off, including four reports of pieces of the product found in children's mouths.



# Methodology

## Recalled Toys

We generated the list of recalled toys from the Consumer Product Safety Commission's database of recalled toys.<sup>71</sup> We searched for recalled products from October 2016 to October 2017 and identified items that could be toys if they are meant for use by children or would be gifted to children. We then looked for the toys through online vendors by searching for them on Internet stores and websites. For the toys we were able to buy, we checked the products to determine if they appeared to be part of the recalled batch.

## Lead Hazards

For testing toys for lead, U.S. PIRG Education Fund staff purchased several fidget spinners at local stores. Fidget spinners were tested for lead content by a CPSC-accredited laboratory. The fidget spinners were analyzed in accordance with CPSC-CH-E1001-8.3 using Inductively Coupled Plasma Mass Spectrometry (ICP/MS). The toys that tested for high levels of lead were then re-tested a second time to confirm the results, and the results of the second test are included in this report. The high content of chromium and phthalates in the products we found doesn't necessarily mean that they violate the law, though it is a reason for consumers to worry.

## Choking hazards

We examined toys for potential choking hazards, looking for the following problems:

1. A toy labeled for children under three containing small parts or breaking easily into small parts.
2. A toy containing small parts or small balls but intended for children under three.
3. A toy containing small parts or small balls and intended for children over three, but lacking the statutory choke hazard warning or having a choke hazard warning that is obscured or too small.
4. A toy intended for children under six years that lacks the statutory choke hazard warning and appears to fail the "use and abuse" test, breaking easily into small parts that fit in the choke tube.

We relied on labeling guidelines in ASTM F963-11 to assess compliance with labeling standards. For determining the age of children to whom a particular toy is marketed, we used the CPSC's Age Determination Guidelines regarding size, weight, theme, realism, colors, and level of skill.

# Appendix 1. Potentially Hazardous Toys

## Toxic Metals: Lead

<b>Product Name</b>	<b>Fidget Wild Premium Spinner Brass</b>
<b>Label on Toy</b>	14+ (although we believe this toy is intended for children under 12 years and, at the time of testing, the website included a statement that it's for children 6+)
<b>Type of Hazard</b>	Lead
<b>Why Toy Is a Hazard</b>	The center circle tested for 33,000 ppm lead and the arm tested for 22,000 ppm lead.
<b>Manufacturer/Distributor</b>	Bulls i Toy
<b>Item # (if known)</b>	
<b>UPC (if known)</b>	0-97712-53777-1
<b>Store</b>	Target
<b>Price Paid</b>	\$19.99

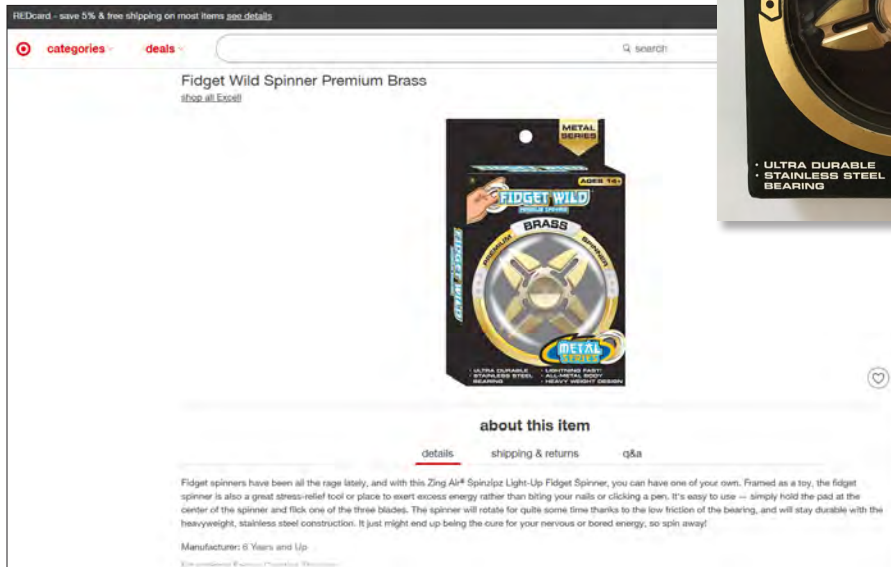

Screenshot from online store website

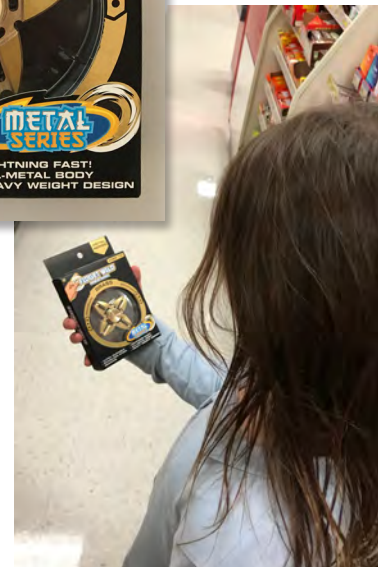

Fidget spinner in Target store

Product Name	<b>Fidget Wild Premium Spinner Metal</b>
Label on Toy	14+ (although we believe this toy is intended for children under 12 years)
Type of Hazard	Lead
Why Toy Is a Hazard	The center circle tested for 1,300 ppm lead and the arm tested for 520 ppm lead.
Manufacturer/Distributor	Bulls i Toy
UPC	0-97629-51843-6
Store	Target
Price Paid	\$9.99





# Choking Hazards: Small Parts

Toys with small parts intended for children between the ages of three and six years old must include the following explicit choke hazard warning (a similar warning is required for toys containing small balls or marbles):



<b>Product Name</b>	<b>Peg Game – Wooden Game</b>
<b>Label on Toy</b>	No age range given; no choke hazard warning
<b>Type of Hazard</b>	Choking – small part
<b>Why Toy Is a Hazard</b>	Pins fit in choke tube
<b>Manufacturer/Distributor</b>	Greenbrier Intl, Inc.
<b>Item # (if known)</b>	186282-19348-001-020117
<b>UPC (if known)</b>	6-39277-01880-9
<b>Store</b>	Dollar Tree
<b>Price Paid</b>	\$1



<b>Product Name</b>	<b>Golf – Wooden Game</b>
<b>Label on Toy</b>	No age range given; no choke hazard warning
<b>Type of Hazard</b>	Choking – small part
<b>Why Toy Is a Hazard</b>	Dice and pins fit in choke tube
<b>Manufacturer/Distributor</b>	Greenbrier Intl, Inc.
<b>Item # (if known)</b>	186282-19348-001-020115
<b>UPC (if known)</b>	6-39277-01880-9
<b>Store</b>	Dollar Tree
<b>Price Paid</b>	\$1



<b>Product Name</b>	<b>Football – Wooden Game</b>
<b>Label on Toy</b>	No age range given; no choke hazard warning
<b>Type of Hazard</b>	Choking – small part
<b>Why Toy Is a Hazard</b>	Dice and pins fit in choke tube
<b>Manufacturer/Distributor</b>	Greenbrier Intl, Inc.
<b>Item # (if known)</b>	186282-19348-001-020117
<b>UPC (if known)</b>	6-39277-01880-9
<b>Store</b>	Dollar Tree
<b>Price Paid</b>	\$1



# Choking Hazard: Balloons

Product Name	Mega Value Pack 14 Latex Punch Balloons
Label on Toy	Statutory balloon warning (Children under 8 can suffocate), the statutory small parts warning (not for children under 3), and a 3+ label.
Type of Hazard	Choking – balloon
Why Toy Is a Hazard	Balloons are dangerous for children under 8, but this package is labeled for 3+.
Manufacturer/Distributor	Amscan
Item # (if known)	392656
UPC (if known)	0-48419-93287-1
Store	Party City
Price Paid	\$5.99



<b>Product Name</b>	<b>Mega Value Pack 12 Water Bomb Packs</b>
<b>Label on Toy</b>	Statutory balloon warning (Children under 8 can suffocate), the statutory small parts warning (not for children under 3), and a 3+ label.
<b>Type of Hazard</b>	Choking – balloon
<b>Why Toy Is a Hazard</b>	Balloons are dangerous for children under 8, but this package is labeled for 3+.
<b>Manufacturer/Distributor</b>	Amscan
<b>Item # (if known)</b>	391768
<b>UPC (if known)</b>	0-48419-68351-3
<b>Store</b>	Party City
<b>Price Paid</b>	\$7.99

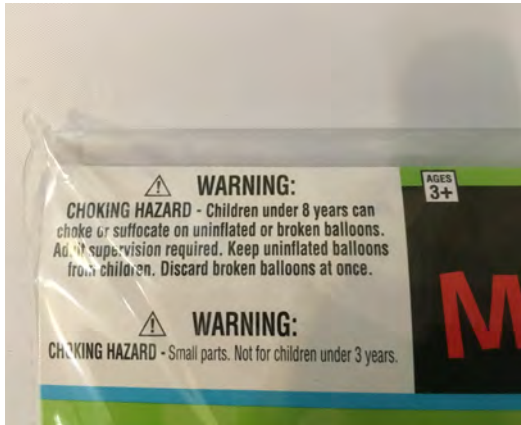

Product Name	Disney Princess Punchball Balloons
Label on Toy	Statutory balloon warning (Children under 8 can suffocate), and a 3+ label.
Type of Hazard	Choking – balloon
Why Toy Is a Hazard	Balloons are dangerous for children under 8, but this package is labeled for 3+.
Manufacturer/Distributor	Greenbrier International, Inc.
Item # (if known)	225946-09510-017-082117
UPC (if known)	0-48419-73408-6
Store	Dollar Tree
Price Paid	\$1

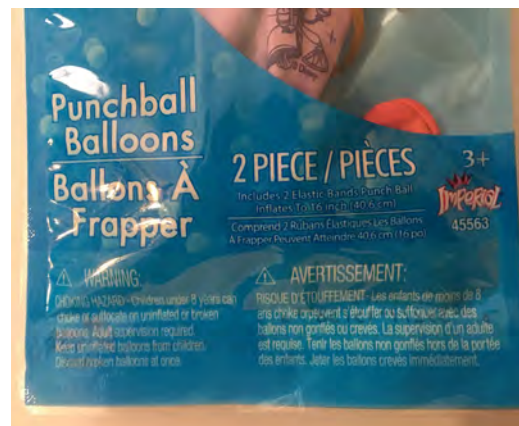

<b>Product Name</b>	<b>H2O Blasters – Water Balloons</b>
<b>Label on Toy</b>	Statutory balloon warning (Children under 8 can suffocate), and the statutory small parts warning (not for children under 3)
<b>Type of Hazard</b>	Choking – balloon
<b>Why Toy Is a Hazard</b>	Although this balloon set doesn't have the "3+" label, the statutory small parts warning saying it's not for children under 3 make it confusing and parents might see that label and think it's appropriate for children 3 and above. However, balloons are dangerous for children under 8.
<b>Manufacturer/Distributor</b>	Greenbrier International, Inc.
<b>Item # (if known)</b>	177685-24472-001-101816
<b>UPC (if known)</b>	6-39277-77685-3
<b>Store</b>	Dollar Tree
<b>Price Paid</b>	\$1



<b>Product Name</b>	<b>Party Balloons - 10</b>
<b>Label on Toy</b>	The statutory small parts warning (not for children under 3)
<b>Type of Hazard</b>	Choking – balloon
<b>Why Toy Is a Hazard</b>	Balloons are dangerous for children under 8, but this package only contains the small parts warning label that it's not for children under 3. It does not contain the statutory balloon warning (Children under 8 can suffocate).
<b>Manufacturer/Distributor</b>	NA
<b>Item # (if known)</b>	HW858
<b>UPC (if known)</b>	NA
<b>Store</b>	Dollar City Plus
<b>Price Paid</b>	\$1.49



# Data-Collecting Toys

Product Name	My Friend Cayla (Brunette or Blonde)
Label on Toy	Choking hazard small parts (not for children under 3 years), and 4+ label
Type of Hazard	Data collection – child privacy concerns
Why Toy Is a Hazard	The doll can collect data which may pose a children’s privacy law violation
Manufacturer/Distributor	Genesis
UPC (if known)	0-26753-05660 (Brunette) & 0-26753-01242-8 (Blonde)
Store	Kohl’s (Brunette) and Walmart (Blonde)
Price Paid	\$39.99 (Brunette) and \$27.90 (Blonde)





## Appendix 2. Reported Toy-Related Deaths, 2001-2015

### Toy-Related Deaths in Children Younger than 15, 2001-2015<sup>72</sup>

	2001	2002	2003	2004	2005	2006	2007	2008	2009	2010	2011	2012	2013	2014	2015	2001-2015 total
Choking/ Asphyxiation																
Balloons	4	3	3	3	2	3	4	2	2	5	5	3	2	3	1	45
Marbles/ Rubber balls/ other small ball	1	2	5	4	9	4	5	2	0	3	0	1	1	0	0	37
Toy or Toy Part	3	3	3	2	0	5	1	1	2	2	0	3	4	2	1	32
<b>Sub-total</b>	<b>8</b>	<b>8</b>	<b>11</b>	<b>9</b>	<b>11</b>	<b>12</b>	<b>10</b>	<b>5</b>	<b>4</b>	<b>10</b>	<b>5</b>	<b>7</b>	<b>7</b>	<b>5</b>	<b>2</b>	<b>114</b>
Riding Toys, Scooters, Tricycles	13	5	0	5	8	11	8	10	8	1	5	7	2	8	5	96
Toy Boxes	2	0	0	0	0	0	0	1	1	2	1	0	NA	NA	NA	7
Other	2	0	0	8	7	5	6	9	4	6	8	1	3	3	4	66
<b>Total</b>	<b>25</b>	<b>13</b>	<b>11</b>	<b>22</b>	<b>26</b>	<b>28</b>	<b>24</b>	<b>25</b>	<b>17</b>	<b>19</b>	<b>19</b>	<b>15</b>	<b>12</b>	<b>16</b>	<b>11</b>	<b>283</b>
% Choking/Asphyxia	32%	62%	100%	41%	42%	43%	42%	20%	24%	53%	26%	47%	58%	31%	18%	40%

## Appendix 3. CPSC Characteristics of Toys for Children Under Three

The following are some general characteristics that make toys appealing to children under three.

**Size and Weight:** Small and lightweight, easy to handle.

**Theme:** Represents a common object found around the home, farm, or neighborhood.

**Degree of Realism:** Silly or cute, some realistic details.

**Colors:** Bright, contrasting colors covering large areas of the toy.

**Noisemaking:** Not loud or frightening.

**Action and Movement:** May be silly, should be easy for child to cause movement.

**Type and level of skill:** Lets child begin to learn skills or practice skills such as walking, stacking, and sorting; should be slightly beyond child's capabilities to maintain interest.

# Endnotes

1 U.S. Consumer Product Safety Commission, Toy-Related Deaths and Injuries, November 2016, available at [https://www.cpsc.gov/s3fs-public/Toy\\_Report\\_2015\\_0.pdf](https://www.cpsc.gov/s3fs-public/Toy_Report_2015_0.pdf).

2 News release, “CPSC Prohibits Certain Phthalates in Children’s Toys and Child Care Products,” 20 October 2017, available at <https://cpsc.gov/newsroom/news-releases/2018/cpsc-prohibits-certain-phthalates-in-childrens-toys-and-child-care-products>.

3 See “Zen Magnets v. CPSC,” Petition for Review of the Consumer Products Safety Commission (CPSC No. CPSC 2012 0050), 22 November 2016, Decision available at <https://www.ca10.uscourts.gov/opinions/14/14-9610.pdf>.

4 See Item 163 on the “In the Matter of Zen Magnets” Docket, 26 October 2017, at the CPSC’s “Recall Lawsuits: Adjudicative Proceedings” page, available at <https://www.cpsc.gov/Recalls/Recall-Lawsuits/Adjudicative-Proceedings>.

5 News Release, Consumer Federation of America, U.S. PIRG and others, “Eighth IKEA Dresser Death Identified: Two-Year-Old Boy Killed in California: Consumer Advocates Demand Effective Action from IKEA and the U.S. Consumer Product Safety Commission,” 18 October 2017, available at [http://consumerfed.org/press\\_release/eighth-ikea-dresser-death-identified-two-year-old-boy-killed-california/](http://consumerfed.org/press_release/eighth-ikea-dresser-death-identified-two-year-old-boy-killed-california/)

6 U.S. Consumer Product Safety Commission, Recall Listing, <https://www.cpsc.gov/Recalls>, (accessed on 2 November, 2017).

7 Centers for Disease Control and Prevention, Fourth National Report on Human Exposure to Environmental Chemicals, February 2009.

8 Centers for Disease Control and Prevention, Lead: Toys, [www.cdc.gov/nceh](http://www.cdc.gov/nceh), (accessed on 2 November, 2017).

9 Centers for Disease Control and Prevention, Lead: Prevention Tips, [www.cdc.gov/nceh](http://www.cdc.gov/nceh), (accessed on 2 November, 2017).

10 Ibid.

11 Ibid.

12 Ibid.

13 Consumer Product Safety Commission, Total Lead Content, <http://www.cpsc.gov/en/Business--Manufacturing/Business-Education/Lead/Total-Lead-Content/>, (accessed on 2 November, 2017).

14 Ibid.

15 Ibid.

16 American Academy of Pediatrics, Testimony of Dana Best, MD, MPH, FAAP, on Behalf of the American Academy of Pediatrics: Energy and Commerce Subcommittee on Commerce, Trade, and Consumer Protection: Protecting Children from Lead Paint Imports, 20 September 2007.

17 Fidget Wild Spinner Premium Brass. Target.com. Available at <https://www.target.com/p/fidget-wild-spinner-premium-brass/-/A-52702329>. Accessed on Oct. 30, 2017. Note that as of Nov. 10, 2017, the 6+ statement was changed to 14+.

18 U.S. Consumer Product Safety Commission. Statement from Acting Chairman Ann Marie Buerkle Regarding Fidget Spinners. 10 Aug. 2017. Available at <https://www.cpsc.gov/about-cpsc/chairman/ann-marie-buerkle/statements/statement-from-acting-chairman-ann-marie-buerkle-1>.

19 See Appendix 1 for screenshot from Target.com website taken on Oct. 27, 2017.

20 Target, Corp. and Bulls i Toy, L.L.C. responded to U.S. PIRG Education Fund on Nov. 6, 2017 via email.

21 American Chemistry Council, Phthalates, <http://phthalates.americanchemistry.com/>, (accessed on 2 November 2017).

22 Male development: National Institutes of Health, National Library of Medicine, Tox Town, Phthalates, [toxtown.nlm.nih.gov/text\\_version/chemicals.php?id=24](http://toxtown.nlm.nih.gov/text_version/chemicals.php?id=24), (accessed on 2 November, 2017); Early puberty: I. Colon, et al., "Identification of Phthalate Esters in the Serum of Young Puerto Rican Girls with Premature Breast Development," *Environmental Health Perspectives* 108: 895-900, 2000.

23 National Institutes of Health, National Library of Medicine, Tox Town, Phthalates, [toxtown.nlm.nih.gov/text\\_version/chemicals.php?id=24](http://toxtown.nlm.nih.gov/text_version/chemicals.php?id=24), (accessed on 2 November, 2017).

24 Consumer Product Safety Commission, CPSC Prohibits Certain Phthalates in Children's Toys and Child Care Products, <https://www.cpsc.gov/Newsroom/News-Releases/2018/CPSC-Prohibits-Certain-Phthalates-in-Childrens-Toys-and-Child-Care-Products>, (accessed on 2 November, 2017).

25 Ibid.

26 See note 1.

27 Consumer Product Safety Commission, Office of Compliance, Small Parts Regulations: Toys and Products Intended for Use by Children Under 3 Years Old: 16 C.F.R Part 1501 and 1500.50-53, January 2001

28 16 CFR 1500.19(b)(1).

29 Marbles: 16 CFR 1500.19(a)(4)(i); vending machines and toy bins: 16 CFR 1500.19(a)(8).

30 16 CFR 1501.2(b).

31 16 CFR 1501.3.

32 16 CFR 1500.18(a)(17).

33 See note 1.

34 16 CFR 1500.18(a)(17).

35 16 CFR 1500.19(b)(3)(i).

36 Ibid.

37 Consumer Product Safety Commission, CPSC Safety Alert: CPSC Warns Consumers of Suffocation Danger Associated with Children's Balloons, 2012.

38 See note 1.

39 16 CFR 1500.19(b)(2).

40 Consumer Product Safety Commission, CPSC Warns High-Powered Magnets and Children Make a Deadly Mix, [www.cpsc.gov/Newsroom/News-Releases/2012/CPSC-Warns-High-Powered-Magnets-and-Children-Make-a-Deadly-Mix/](http://www.cpsc.gov/Newsroom/News-Releases/2012/CPSC-Warns-High-Powered-Magnets-and-Children-Make-a-Deadly-Mix/), (accessed on 2 November, 2017).

41 Teri Sforza, “Watchdog: Magnets in Toys Can Be Deadly,” *Orange County Register*, 1 October 2015; Consumer Federation of America, CPSC Issues Final Rule to Protect Children from Hazardous High Powered Magnets (press release), 24 September 2014; Elizabeth Cohen, “Powerful Magnets in Toys Raise Risks from Swallowing,” *CNN*, 5 June 2012; Consumer Product Safety Commission, CPSC Approves Strong Federal Safety Standards for High Powered Magnet Sets to Protect Children and Teenagers (press release), 25 September 2014.

42 Consumer Product Safety Commission, CPSC Approves Strong Federal Safety Standards for High-Powered Magnet Sets to Protect Children and Teenagers (press release), 25 September 2014.

43 Jayne O’Donnell, “CPSC May Ban Tiny Magnets that Killed a Child,” *USA Today*, 4 September 2014.

44 Consumer Federation of America, Pediatricians and Consumer Advocates Ask CPSC for Swift Action on High-Powered Magnet Safety Standards (press release), 1 October 2015.

45 Consumer Product Safety Commission, CPSC Approves Strong Federal Safety Standard for High-Powered Magnet Sets to Protect Children and Teenagers, <http://www.cpsc.gov/Newsroom/News-Releases/2014/CPSC-Approves-Strong-Federal-Safety-Standard-for-High-Powered-Magnet-Sets-to-Protect-Children-and-Teenagers/>, (accessed on 2 November, 2017).

46 Matt Strickland, Daniel Rosenfield and Annie Fecteau, “Magnetic Foreign Body Injuries: A Large Pediatric Hospital Experience,” *The Journal of Pediatrics* 165 (2): 332-335, May 2014.

47 See note 6.

48 Federal Register, Final Rule: Safety Standard for Magnet Sets: A Rule by the Consumer Product Safety Commission, 3 October 2014.

49 ASTM International, F963-11, Standard Consumer Safety Specification for Toy Safety (West Conshohocken, PA: ASTM International, 2012).

50 Jayne O’Donnell, “CPSC Buckyballs Settlement Gives Buyers Refunds,” *USA Today*, 17 July 2014; and Consumer Product Safety Commission, Recall Lawsuits: Adjudicative Proceedings, <http://www.cpsc.gov/en/Recalls/Recall-Lawsuits/Adjudicative-Proceedings/>, (accessed on 2 November, 2017).

51 See “Zen Magnets v. CPSC,” Petition for Review of the Consumer Products Safety Commission (CPSC No. CPSC 2012 0050), 22 November 2016, Decision available at <https://www.ca10.uscourts.gov/opinions/14/14-9610.pdf>

52 See Item 163 on the “In the Matter of Zen Magnets” Docket, 26 October 2017, at the CPSC’s “Recall Lawsuits: Adjudicative Proceedings” page, available at <https://www.cpsc.gov/Recalls/Recall-Lawsuits/Adjudicative-Proceedings>

53 For an explanation of COPPA, see the FTC’s “Children’s Privacy” page, available at <https://www.ftc.gov/tips-advice/business-center/privacy-and-security/children%27s-privacy>.

54 Stacey Gray, “Federal Trade Commission: COPPA Applies to Connected Toys,” Blog Post 26 June 2017, available at <https://fpf.org/2017/06/26/federal-trade-commission-coppa-applies-connected-toys/>.

55 FBI Public Service Announcement I-071717(Revised), “CONSUMER NOTICE: INTERNET-CONNECTED TOYS COULD PRESENT PRIVACY AND CONTACT CONCERNS FOR CHILDREN,” 17 July 2017, available at <https://www.ic3.gov/media/2017/170717.aspx>.

56 Soraya Sarhaddi Nelson, “Germany Bans ‘My Friend Cayla’ Doll Over Spying Concerns”, 20 February 2017, available at <http://www.npr.org/2017/02/20/516292295/germany-bans-my-friend-cayla-doll-over-spying-concerns> Additional information on Cayla tests conducted by the Norwegian Consumer Council is available at <https://www.forbrukerradet.no/siste-nytt/connected-toys-violate-consumer-laws/>.

57 Complaint of Electronic Privacy Information Center, et al, In the Matter of Genesis Toys and Nuance Communications,” filed before the FTC 6 December 2016, available at <https://epic.org/privacy/kids/EPIC-IPR-FTC-Genesis-Complaint.pdf>

58 Note that the privacy and consumer group complaint also alleges COPPA violations by the manufacturer’s robot toy, “I-Que,” from the manufacturer. We were unable to purchase I-Que online or in stores.

59 Complaint of Electronic Privacy Information Center, et al, In the Matter of Genesis Toys and Nuance Communications,” filed before the FTC 6 December 2016, available at <https://epic.org/privacy/kids/EPIC-IPR-FTC-Genesis-Complaint.pdf>

60 Ibid.

61 News Release, ““Smartwatches” For Parents to Monitor Young Children Actually Pose a Danger to Kids’ Welfare”, 18 October 2017, available at <http://www.commercialfreechildhood.org/“smartwatches”-parents-monitor-young-children-actually-pose-danger-kids’-welfare>

62 The guide, published in June 2013, is available at <https://www.democraticmedia.org/content/protecting-childrens-online-privacy-parents-guide-new-stronger-kids-privacy-rules-digital>

63 National Institute on Deafness and Other Communication Disorders, National Institutes of Health, U.S. Department of Health and Human Services, NIDCD Fact Sheet: Noise Induced Hearing Loss, December 2008.

64 A.S. Niskar, et al., “Prevalence of Hearing Loss among Children 6 to 19 Years of Age: The Third National Health and Nutrition Examination Survey,” *Journal of the American Medical Association* 279: 1071-1075, 1998.

65 American Speech-Language-Hearing Association, The Prevalence and Incidence of Hearing Loss in Children, <http://www.asha.org/public/hearing/Prevalence-and-Incidence-of-Hearing-Loss-in-Children/>, (accessed on 2 November, 2017).

66 Sight and Hearing Association, *Sound Off: Noisy Toys Pose Hearing Threat*, 2011.

67 ASTM International, F963-11, Standard Consumer Safety Specification for Toy Safety (West Conshohocken, PA: ASTM International, 2012).

68 Kids in Danger, *Smoldering Hazards: Fire and Burn Hazards of Children’s Product Recalls*, 2007. [http://www.kidsindanger.org/docs/reports/2007\\_burn\\_report.pdf](http://www.kidsindanger.org/docs/reports/2007_burn_report.pdf).

69 See note 6.

70 Ibid.

71 Ibid.

72 See note 1.